

TRIM BOOK

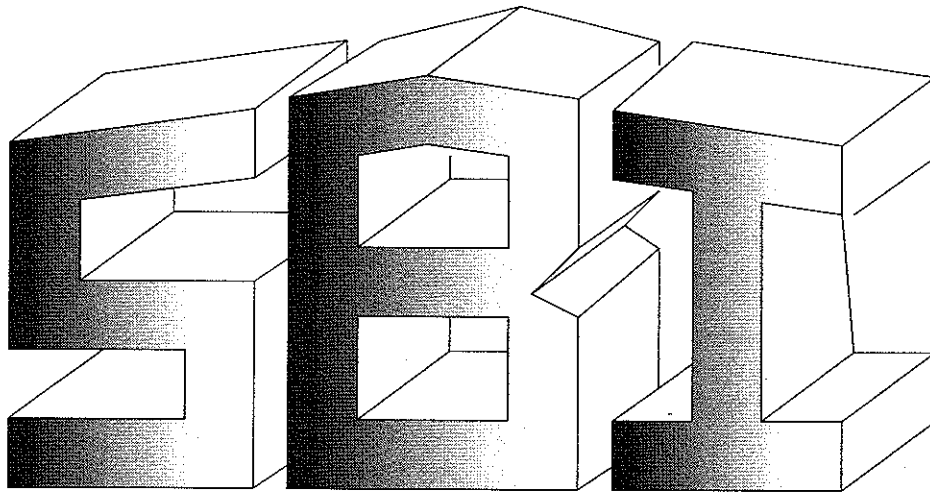

METAL BUILDINGS

114 TROOPER DRIVE
HOT SPRINGS, ARKANSAS 71913
PH: (501) 262-0600, FAX: (501) 262-5107

VERSION 1.0

6-11-2009

DRAWN:JJM

TRIM BOOK INDEX

PART #	DESCRIPTION	S.O.	HEM	PG#
"PBR"				
FL-14	BOX EAVE GUTTER	21 1/2"	(1) 1/2"	P1
FL-16	"PBR" PANEL SCULPTURED RAKE	21 1/2"	(2) 1/2"	P2
FL-17	SCULPTURED HIGH SIDE EAVE	21 1/2"	(2) 1/2"	P3
FL-18	SCULPTURED EAVE GUTTER	23 1/4"	(1) 1/2"	P4
FL-18C	SCULPTURED HANG-ON GUTTER	21 1/2"	(1) 1/2"	P5
FL-19	EAVE TRIM	9 1/2"	(1) 1/2"	P6
FL-22	JAMB TRIM	5 1/2"	NONE	P7
FL-24	HEAD TRIM	5 5/8"	(1) 1/2"	P8
FL-27	2"x2" OUTSIDE ANGLE	5"	(2) 1/2"	P9
FL-28	2"x2" INSIDE ANGLE	5"	(2) 1/2"	P10
FL-29	3"x3" OUTSIDE ANGLE	7"	(2) 1/2"	P11
FL-29L	5"x1" OUTSIDE ANGLE	6 1/2"	(1) 1/2"	P12
FL-29S	3"x3" OUTSIDE ANGLE SHEET BUMP	9 1/4"	(2) 1/2"	P13
FL-2910	5"x3" OUTSIDE ANGLE	9"	(2) 1/2"	P14
FL-2910S	5"x3" OUTSIDE ANGLE SHEET BUMP	11 1/4"	(2) 1/2"	P15
FL-2912	7"x3" OUTSIDE ANGLE	11"	(2) 1/2"	P16
FL-2912S	7"x3" OUTSIDE ANGLE SHEET BUMP	13 1/4"	(2) 1/2"	P17
FL-30	3"x3" INSIDE ANGLE	7"	(2) 1/2"	P18
FL-31	DOWNSPOUT (STRAIGHT)	16"	NONE	P19
FL-31A	DOWNSPOUT (W/ 45 DEGREE ELBOW)	16"	NONE	P20
FL-788	2pc. DOWNSPOUT (W/ 45 DEGREE ELBOW)	16"	NONE	P21
FL-37	JAMB OR HEAD COVER	14 1/8"	(1) 1/2"	P22
FL-3710	JAMB OR HEAD COVER	16 1/8"	(1) 1/2"	P23
FL-3712	JAMB OR HEAD COVER	18 1/8"	(1) 1/2"	P24
FL-38	FLAT RIDGE CAP	21 1/2"	(2) 1/2"	P25
FL-40	SCUPPER	8"	NONE	P26

PART #	DESCRIPTION	S.O.	HEM	PG#
FL-45	SLIDING DOOR HOOD	16 1/2"	(1) 1/2"	P27
FL-46	"PBA" PANEL STARTER	8 3/8"	(1) 1/2"	P28
FL-47	"PBA" JAMB TRIM	7"	NONE	P29
FL-65	U-FLASH LO EAVE	11 1/2"	(1) 1/2"	P30
FL-65S	U-FLASH LO EAVE SHEET BUMP	13 3/4"	(1) 1/2"	P31
FL-6510	U-FLASH LO EAVE	13 1/2"	(1) 1/2"	P32
FL-6510S	U-FLASH LO EAVE SHEET BUMP	15 3/4"	(1) 1/2"	P33
FL-6512	U-FLASH LO EAVE	15 1/2"	(1) 1/2"	P34
FL-6512S	U-FLASH LO EAVE SHEET BUMP	17 3/4"	(1) 1/2"	P35
FL-72	BASE TRIM (ALL PANELS)	6 1/8"	(1) 1/2"	P36
FL-870	BASE FLASHING	9"	NONE	P37
FL-74	BOX HANG-ON GUTTER	17 1/2"	(1) 1/2"	P38
FL-75	LIGHT TRANSMITTING PANEL CAP ("R" PANEL)	6 1/4"	NONE	P39
FL-195	PARAPET HIGH EAVE TRIM	13 3/4"	(1) 1/2"	P40
FL-272	COUNTER FLASHING (USED W/ FL-18C)	8"	(1) 1/2"	P41
FL-451	SLIDING DOOR HOOD	19 1/4"	NONE	P42
FL-556	STANDARD VALLEY	21 1/2"	NONE	P43
FL-797	DOWNSPOUT STRAP	9 3/4"	NONE	P44
FL-800	INSIDE CORNER ("PBR" PANEL)	12 1/2"	(2) 1/2"	P45
FL-830	OS CORNER TRIM ("PBR" & "A" PANEL)	12 1/2"	(2) 1/2"	P46
FL-830F	MODIFIED OS CORNER TRIM ("PBR" & "A" PANEL)	10 3/4"	(2) 1/2"	P47
FL-830S	CORNER TRIM (R PANEL)	16 1/4"	(2) 1/2"	P48
FL-846	MASONRY FLASH	11"	(1) 1/2"	P49
FL-852	PANEL PARAPET RAKE	14"	(1) 1/2"	P50
FL-874	PARAPET HIGH EAVE	12"	(1) 1/2"	P51
FL-893	GUTTER STRAP	3"	NONE	P52
J-77	SOFFIT/FASCIA	15 1/4"	(1) 1/2"	P53

"SSR"				
PART #	DESCRIPTION	S.O.	HEM	PG#
FL-99	GUTTER COUNTER FLASHING	8"	(1) 1/2"	S1
FL-110	SCULPTURED RAKE TRIM	19 1/4"	(2) 1/2"	S2
FL-115	RAKE SLIDE	2 3/4"	(1) 1/2"	S3
FL-213	RIDGE FLASHING FLOATING (1/4" - 2 1/2" PITCH)	21 1/2"	(2) 1/2"	S4
FL-214	RIDGE FLASHING FLOATING (2 1/2" -6"+ PITCH)	23 1/2"	(2) 1/2"	S5
FL-240	SCULPTURED GUTTER (SEE DRAWING FOR S.O.)	VARIES	NONE	S6
FL-250	SCULPTURED EAVE TRIM	15 1/4"	(1) 1/2"	S7
FL-265	SCULPTURED HIGH SIDE EAVE TRIM	20 3/8"	(2) 1/2"	S8
FL-275	PARAPET HIGH SIDE	12 1/2"	(1) 1/2"	S9
FL-276	PARAPET HIGH SIDE EAVE FLASH, FIXED	12"	(1) 1/2"	S10
FL-285	PARAPET RAKE FLASH, FLOATING	11"	(1) 1 5/8" OPEN	S11
FL-291	PARAPET RAKE CLEAT	2 1/2"	(1) 1/2"	S12
FL-332	SIMPLE HIGH SIDE EAVE TRIM	16 7/8"	(2) 1/2"	S13
FL-335	PANEL STARTER	3"	(1) 1/2" OPEN	S14
FL-338	CONTINUOUS CLEAT	3"	NONE	S15
FL-341	COUNTER FLASHING	4 1/2"	(1) 1/2"	S16
FL-360	"Z" CLOSURE	5"	NONE	S17
FL-700	VALLEY TRIM	30 1/4"	NONE	S18
"TUFF"				
LG-101	RIDGE CAP	21 1/2"	(2) 1/2"	T1
LG-103	PEAK TRIM	11 5/8"	(2) 1/2"	T2
LG-110A	BASE TRIM	5 5/16"	NONE	T3
LG-113	CORNER TRIM	11 1/4"	(2) 1/2"	T4
LG-115	INSIDE CORNER	11 1/4"	(2) 1/2"	T5
LG-117	CORNER TRIM	15 1/4"	(2) 1/2"	T6
LG-120	EAVE TRIM	6 5/8"	(1) 1/2"	T7
LG-123	JAMB TRIM	4 1/4"	NONE	T8
LG-124	SOFFIT CAP TRIM/HEAD TRIM	6 3/8"	(1) 1/2"	T9

PART #	DESCRIPTION	S.O.	HEM	PG#
LG-129	DRIP CAP	3 5/8"	(1) 1/2"	T10
LG-138	VALLEY TRIM	20"	NONE	T11
"ARCH"				
T-5075	RIDGE/HIP FLASH, FIXED	14"	(2) 1/2"	A1
T-5087	RIDGE FLASH, FLOATING	16 1/2"	(2) 1/2"	A2
T-5089	RIDGE FLASH FOR PLASTIC VENT	21 1/2"	(2) 1/2"	A3
T-5093	VALLEY TRIM STANDARD	26"	NONE	A4
T-5097	VALLEY TRIM EXTENDED	48"min.	NONE	A5
T-5217	PARAPET RAKE FLASH	9 1/4"	(1) 1/2"CL, (1) 1" OPEN	A6
T-5215	PARAPET HIGH SIDE EAVE FLASH	13"	(1) 1/2"	A7
T-5085	PEAK CAP	16 7/8"	(2) 1/2"	A8
T-5235	BOX RAKE, FIXED	10 5/8"	(2) 1/2"	A9
T-5235M	BOX RAKE, MODIFIED	17 3/8"	(2) 1/2"	A10
T-5237	BOX RAKE, FLOATING	11 5/8"	(2) 1/2"	A11
T-5240	RAKE SLIDE	2 3/8"	(1) 1/2"	A12
T-5141	EAVE TRIM	8 5/8"	(1) 1/2"	A13
T-5261	BOX GUTTER	24"	(1) 1/2"	A14
T-5281	GUTTER STRAP	4"	NONE	A15
T-5131	OFFSET CLEAT	3 1/2"	NONE	A16
T-5102	VENT DRIP	5"	NONE	A17
T-5225	COUNTERFLASH	4 1/2"	(1) 1/2"	A18
T-5221	ALTERNATE COUNTERFLASH	4 1/2"	(2) 1/2"	A19
T-5012	"Z" CLOSURE	4"	NONE	A20
T-5014	"Z" CLOSURE	3 3/4"	NONE	A21
T-5219	PARAPET RAKE CLEAT	2 1/2"	(1) 1/2"	A22
T-5111	PANEL STARTER	3"	(1) 1/2" OPEN	A23

R PANEL

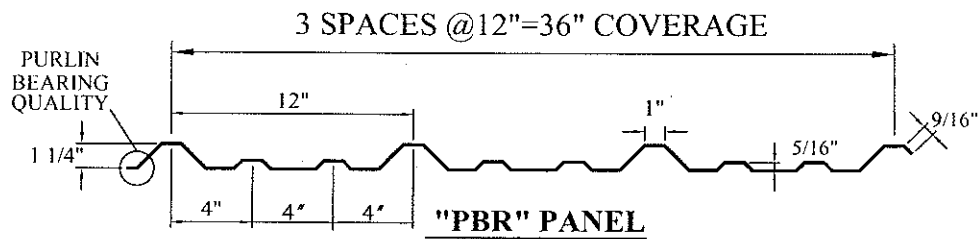

AVAILABLE IN 26Ga GALVALUME & ALL STANDARD COLORS, 24Ga & 26Ga KYNAR COLOR MAYBE AVAILABLE UPON REQUEST.

FL-14

BOX EAVE GUTTER

S.O.: 21 1/2"

pg. P1

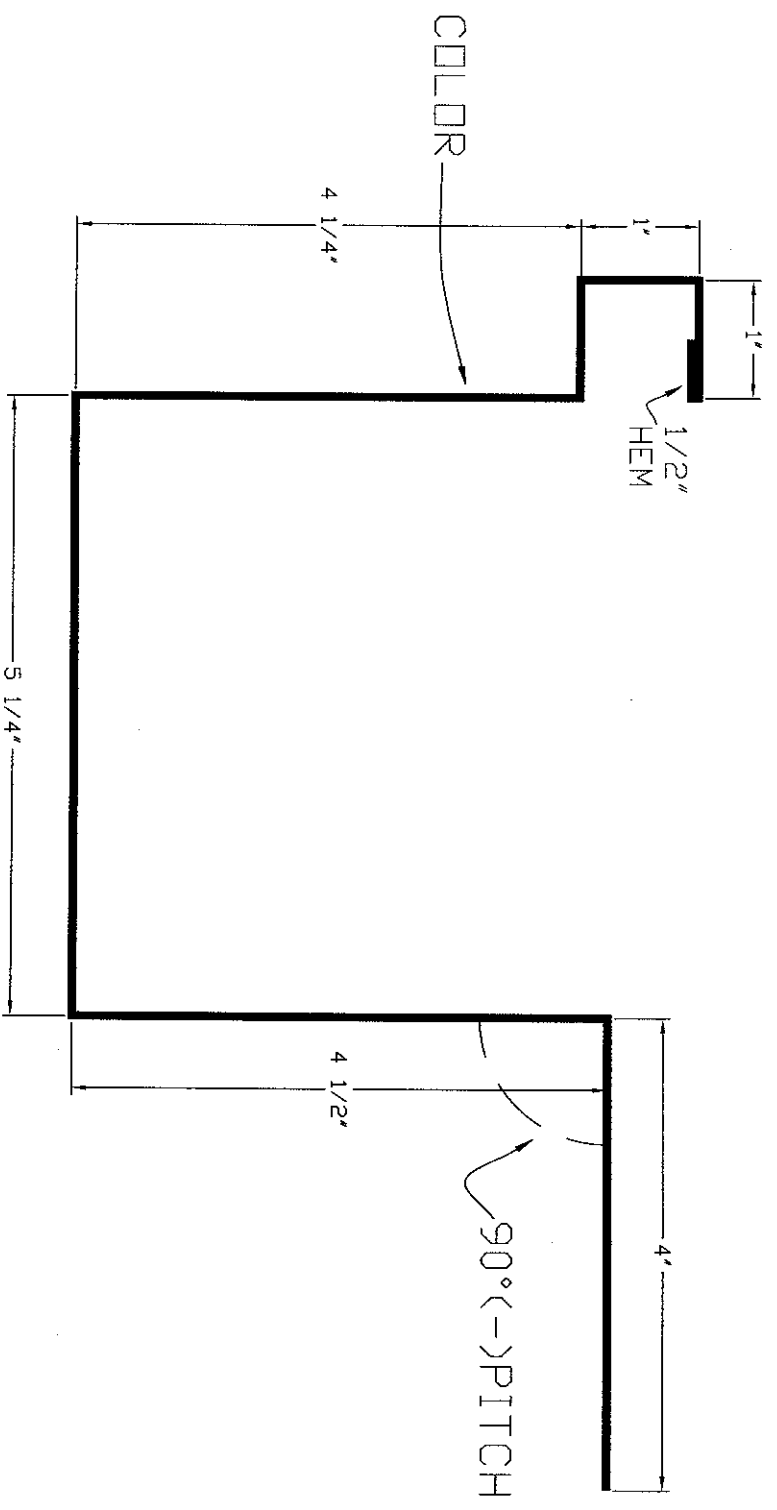

SPECIFY ROOF PITCH

NOTES:

FL-16

"PBR" PANEL SCULPTURED RAKE

S.O.: 21 1/2"

pg. P2

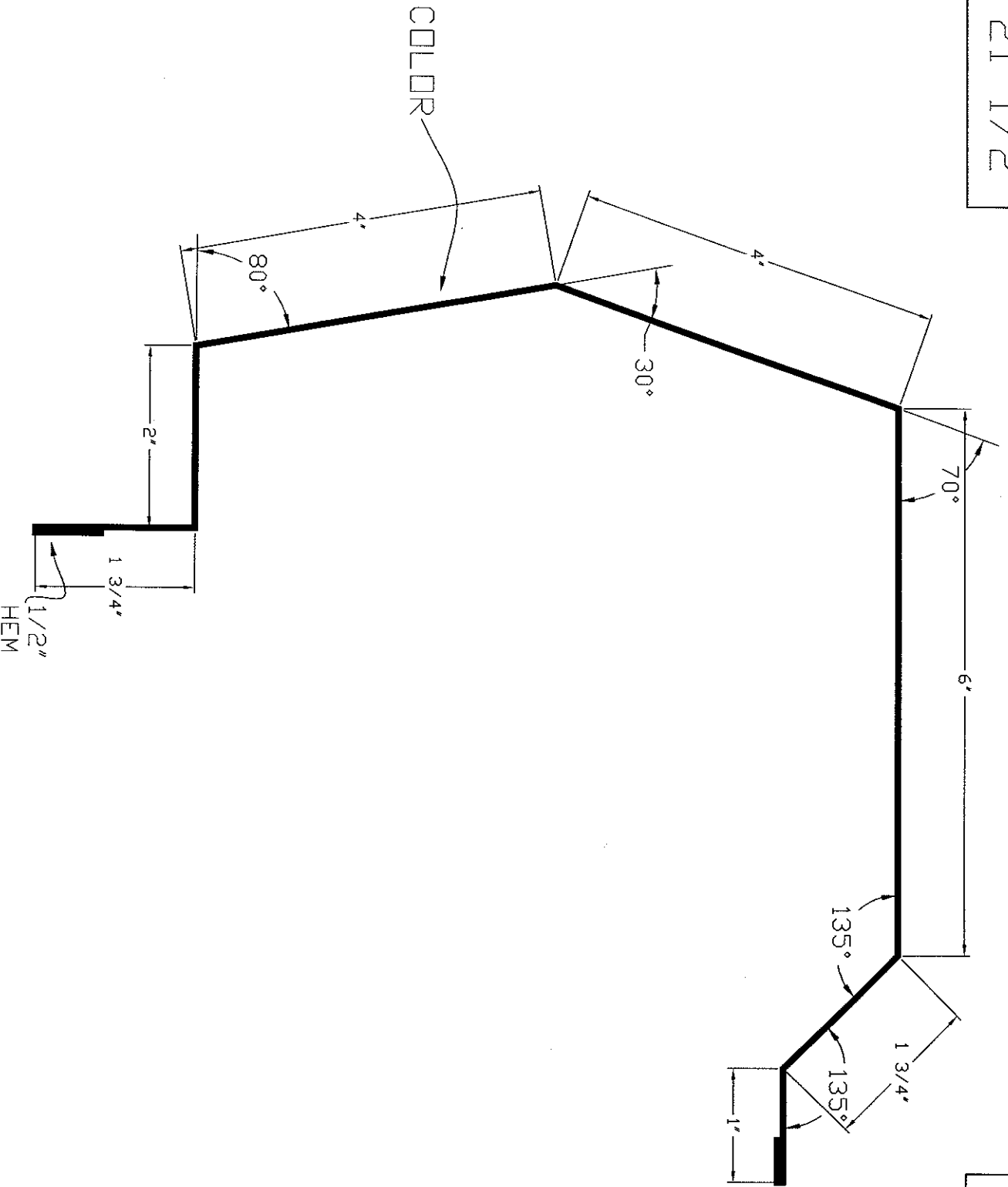

NOTES:

FL-17

SCULPTURED HIGH SIDE EAVE

S.O. 21 1/2"

pg. P3

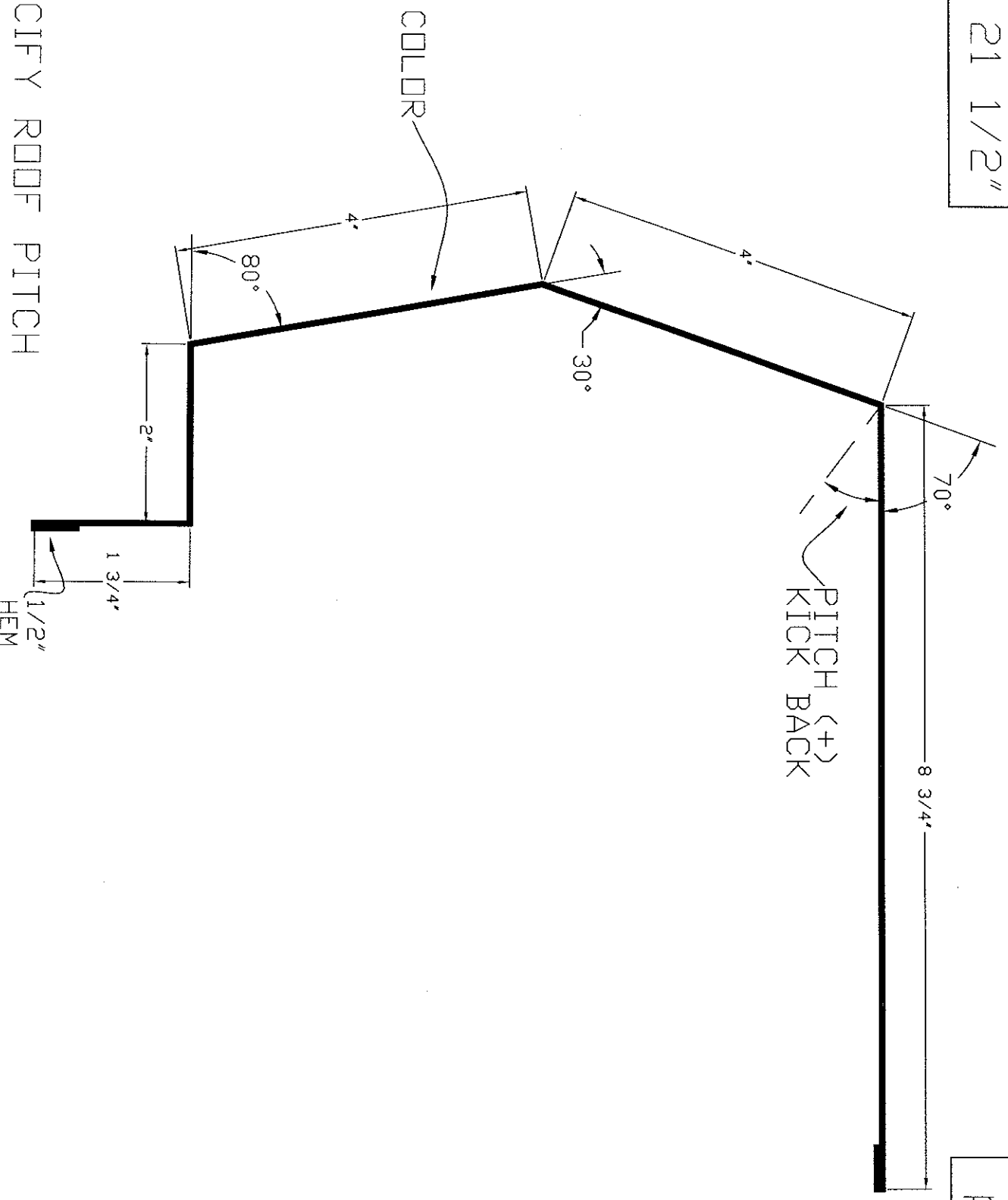

SPECIFY ROOF PITCH

NOTES:

FL-18

SCULPTURED EAVE GUTTER

S.O.: 23 1/4"

pg. P4

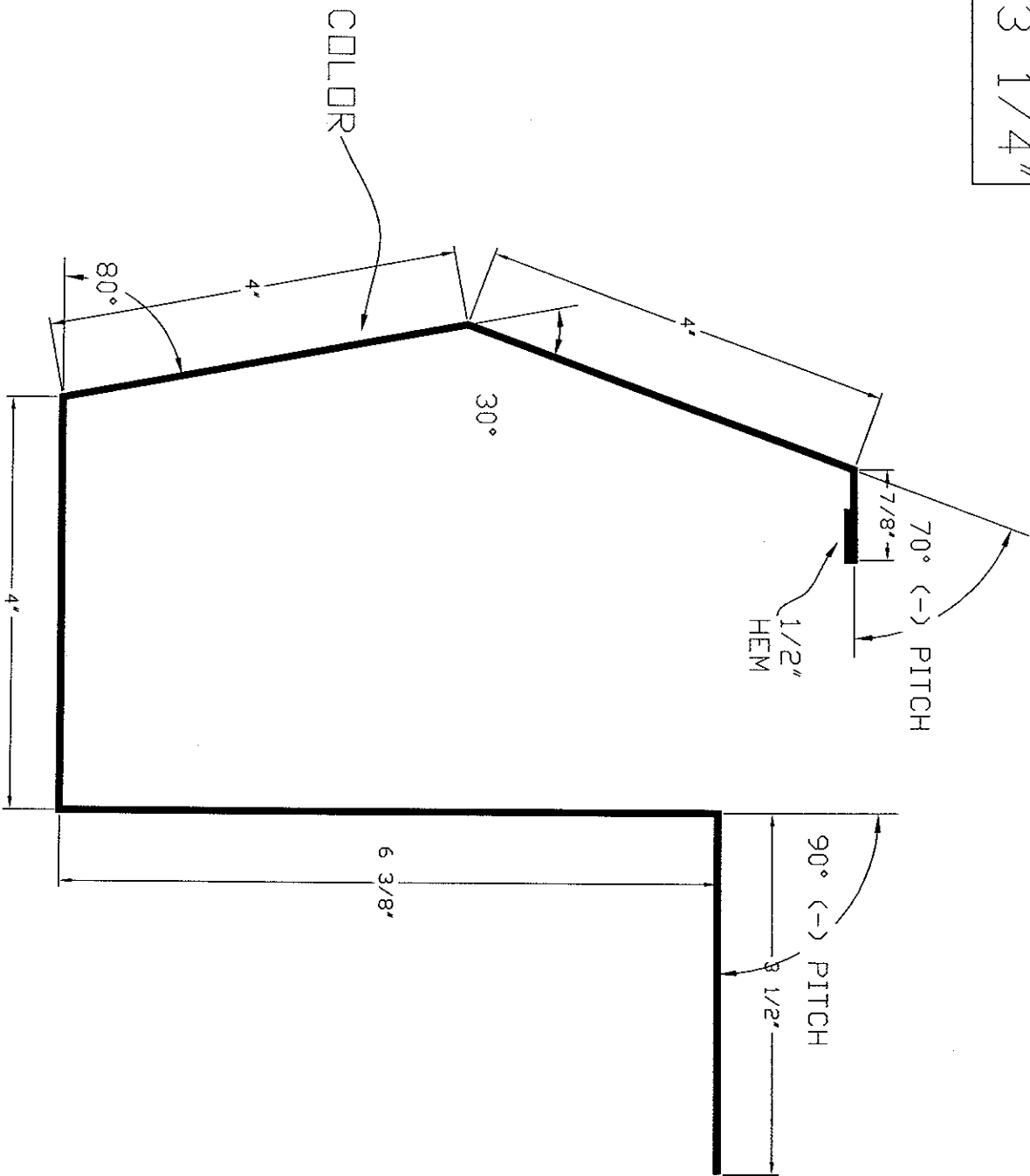

SPECIFY ROOF PITCH

NOTES:

FL-18C

SCULPTURED HANG-ON GUTTER

S.D.: 21 1/2"

pg. P5

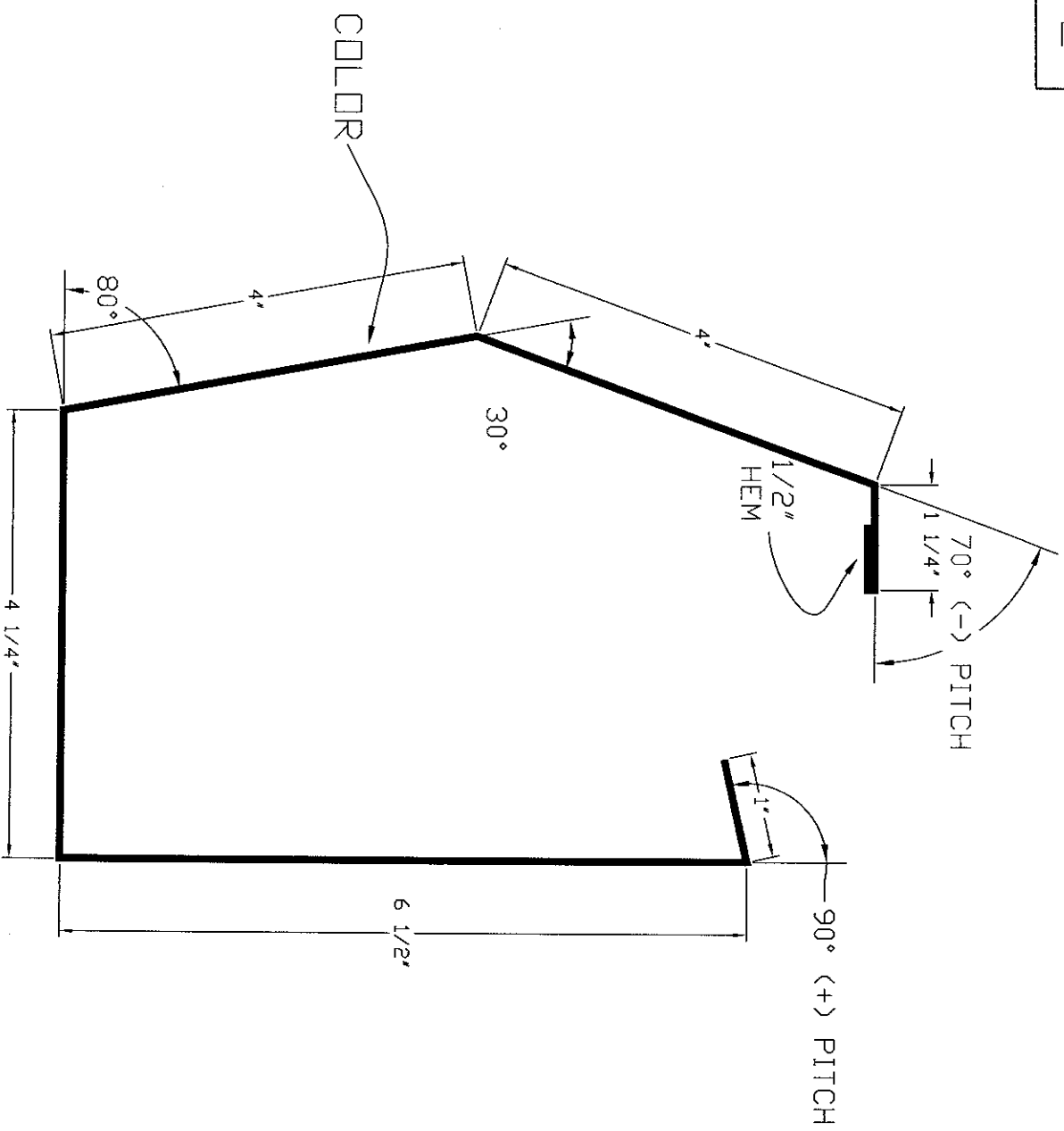

SPECIFY ROOF PITCH

NOTES:

S.O.: 9 1/2"

pg. P6

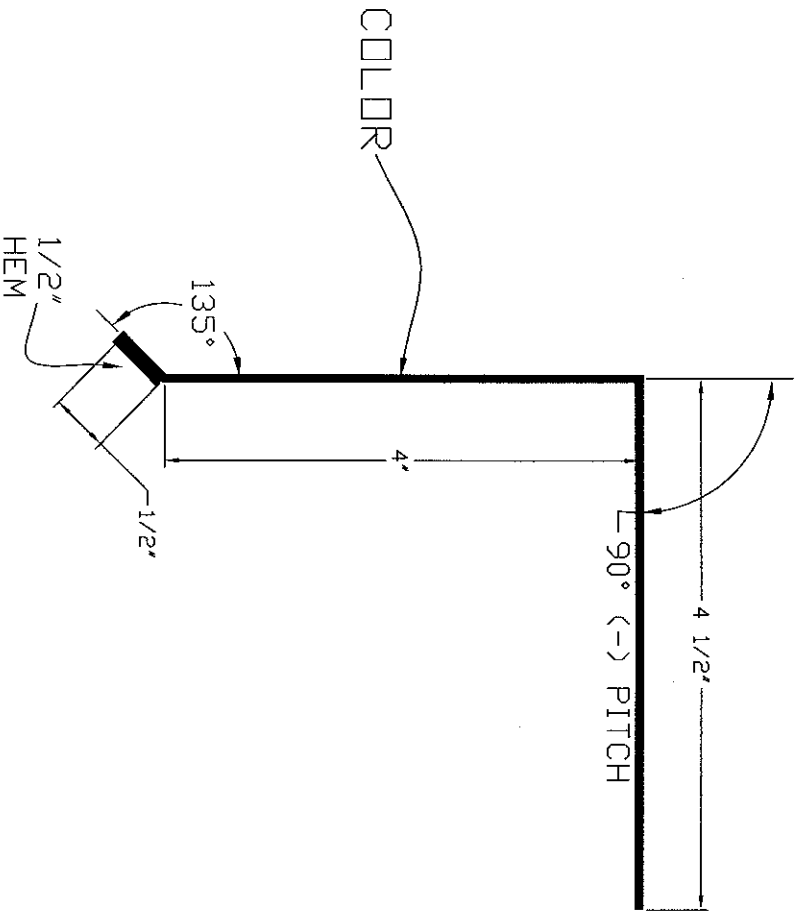

SPECIFY ROOF PITCH

NOTES:

FL-22

JAMB TRIM

S.O. 5 1/2"

pg. P7

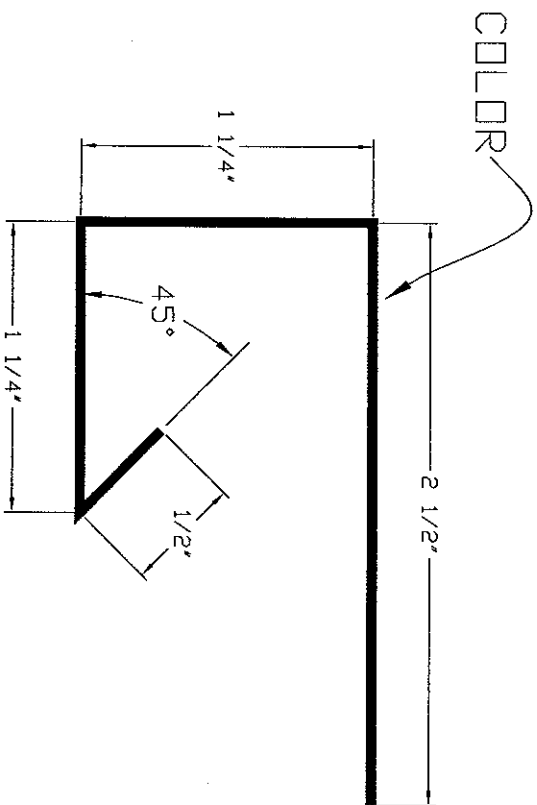

NOTES:

FL-24

HEAD TRIM

S.D.: 5 5/8"

pg. P8

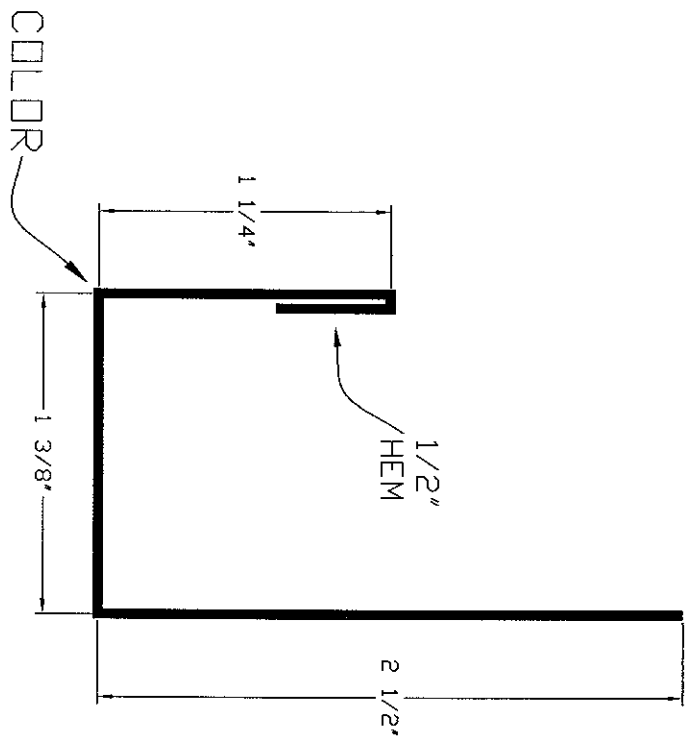

NOTES:

FL-27

2X2 OUTSIDE ANGLE

S.O.: 5"

pg. P9

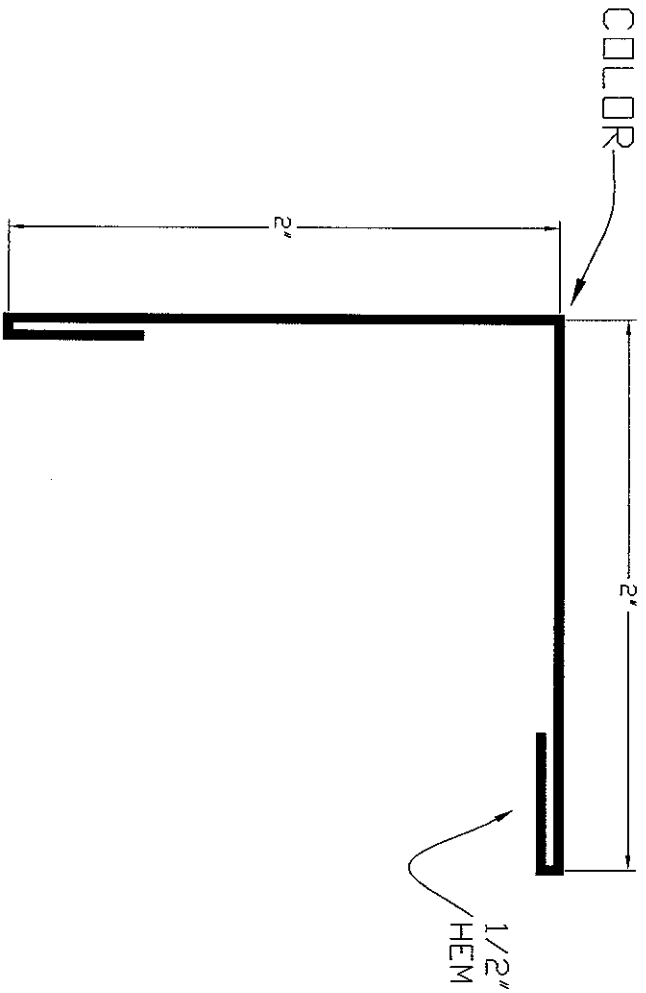

NOTES:

FL-28

2X2 INSIDE ANGLE

S.D. 5"

pg. P10

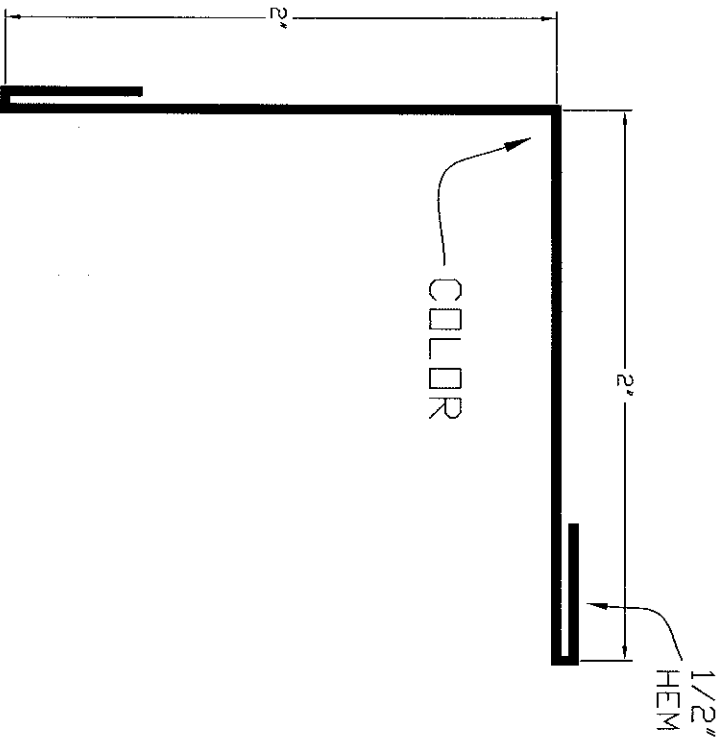

NOTES:

FL-29

3X3 OUTSIDE ANGLE

S.O.: 7"

pg. P11

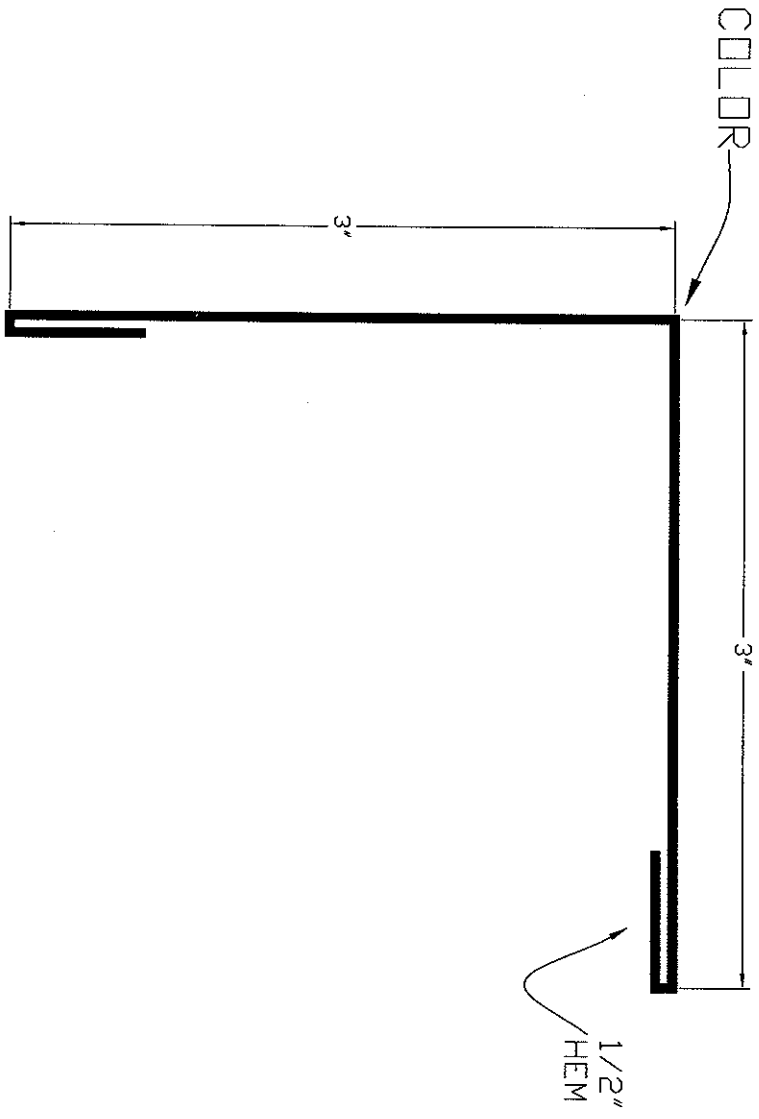

NOTES:

FL-29L

SX1 OUTSIDE ANGLE

S.O.: 6 1/2"

pg. P12

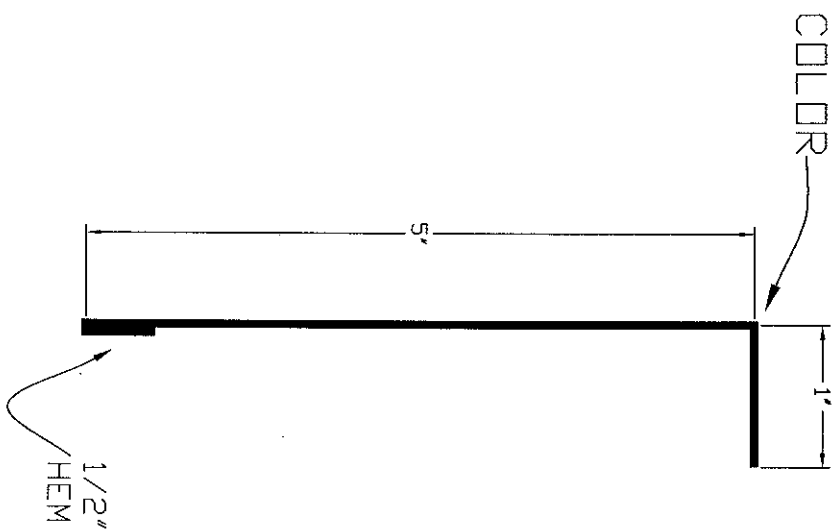

NOTES:

FL-29S

3X3 OUTSIDE ANGLE SHEET BUMP

S.D.: 9 1/4"

pg. P13

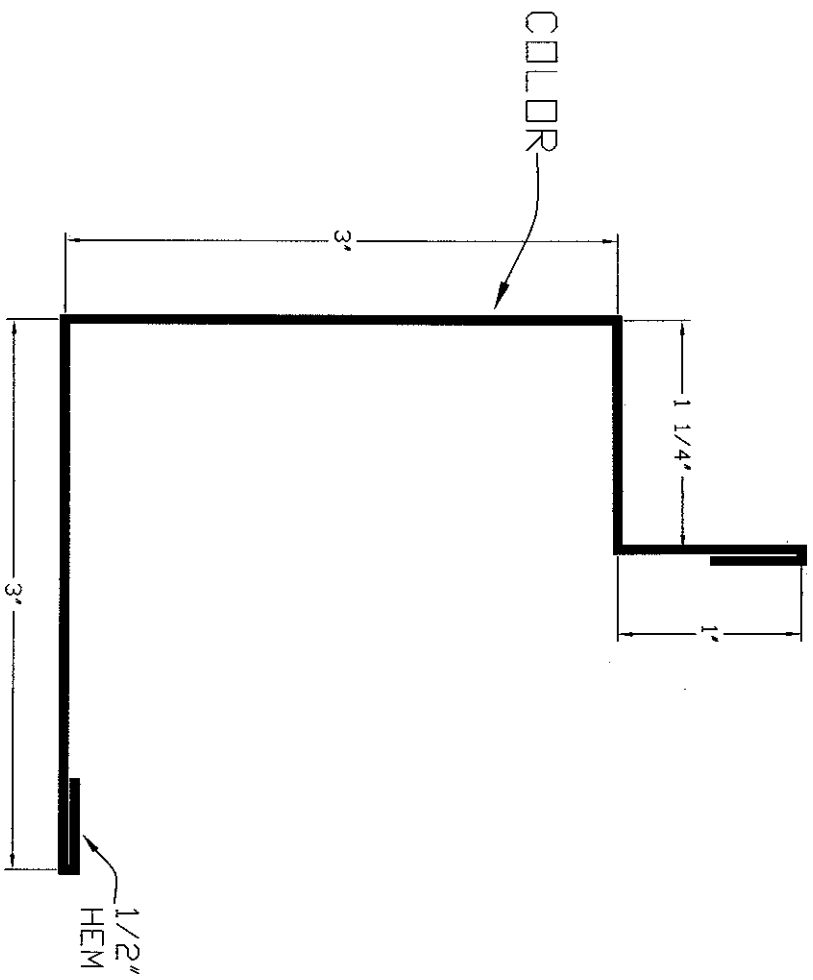

NOTES:

FL-2910

5X3 OUTSIDE ANGLE

S.O.: 9"

pg. P14

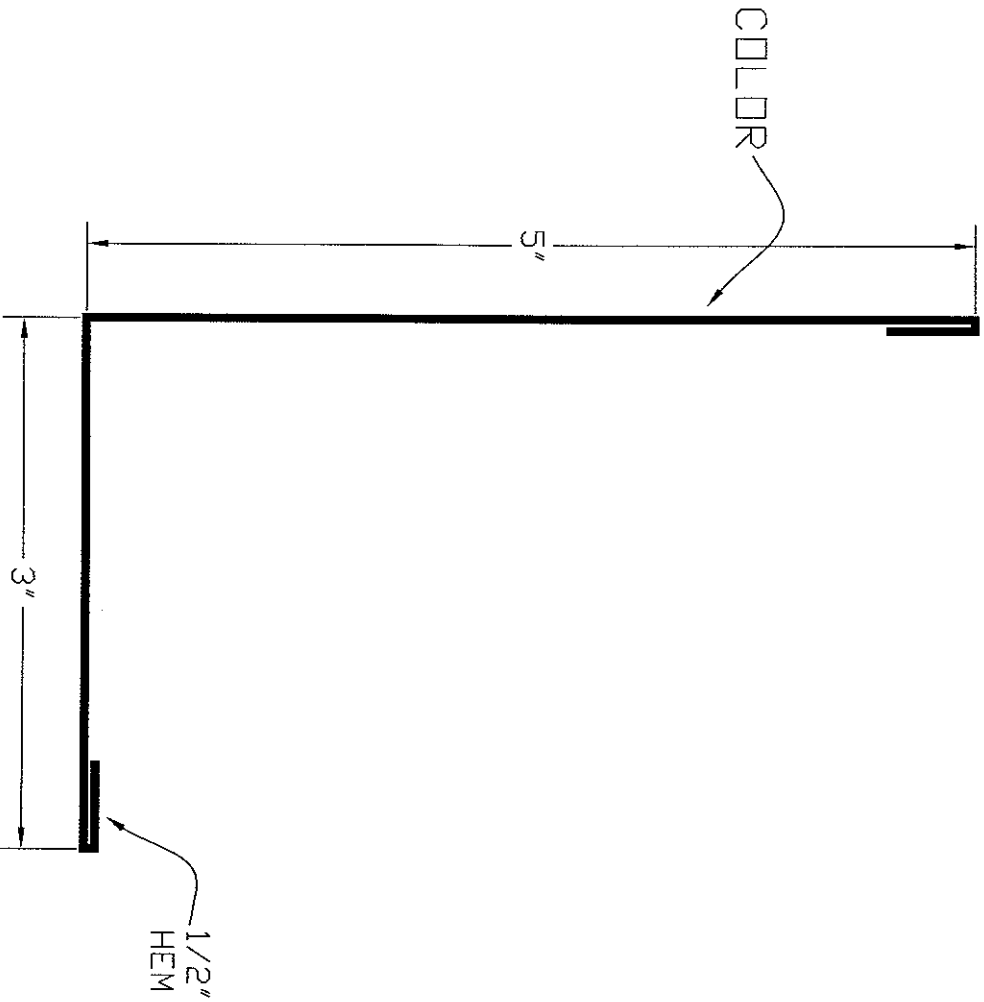

NOTES:

FL-2910S

5X3 OUTSIDE ANGLE SHEET BUMP

S.D.: 11 1/4"

pg. P15

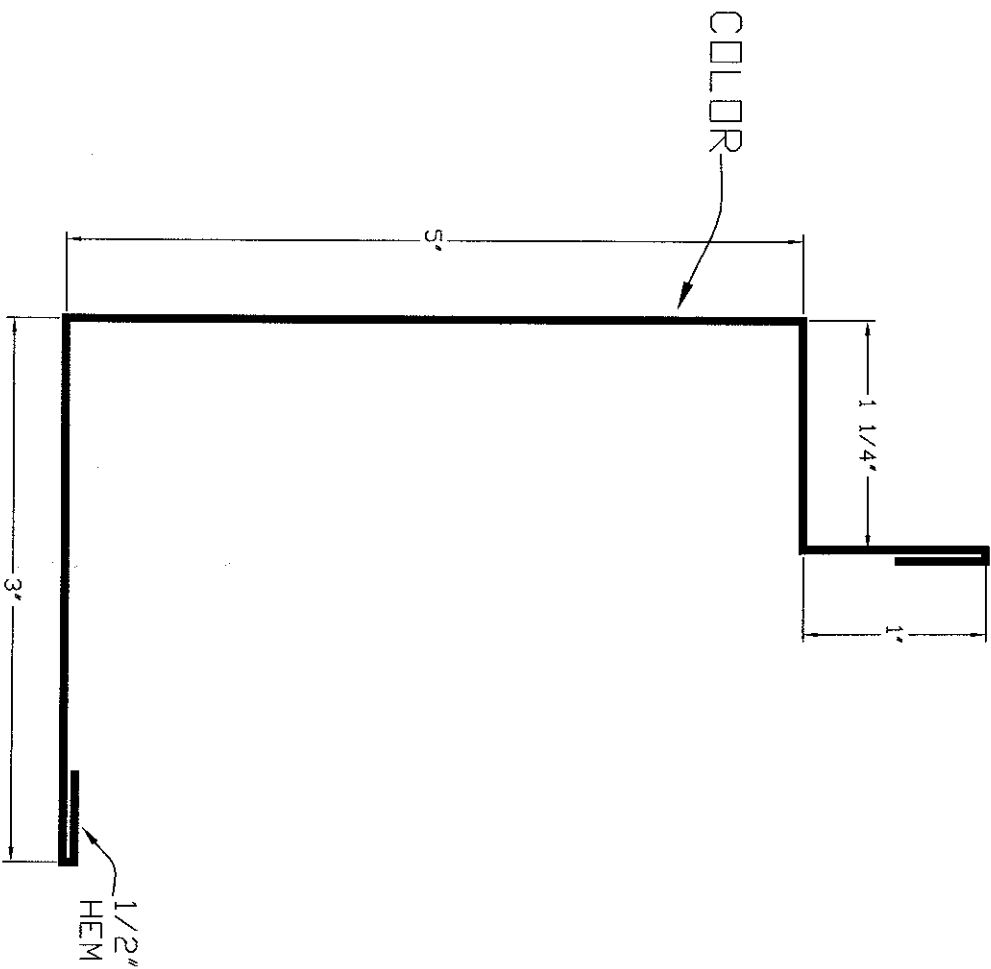

NOTES:

FL-2912

7X3 OUTSIDE ANGLE

S.D. 11"

pg. P16

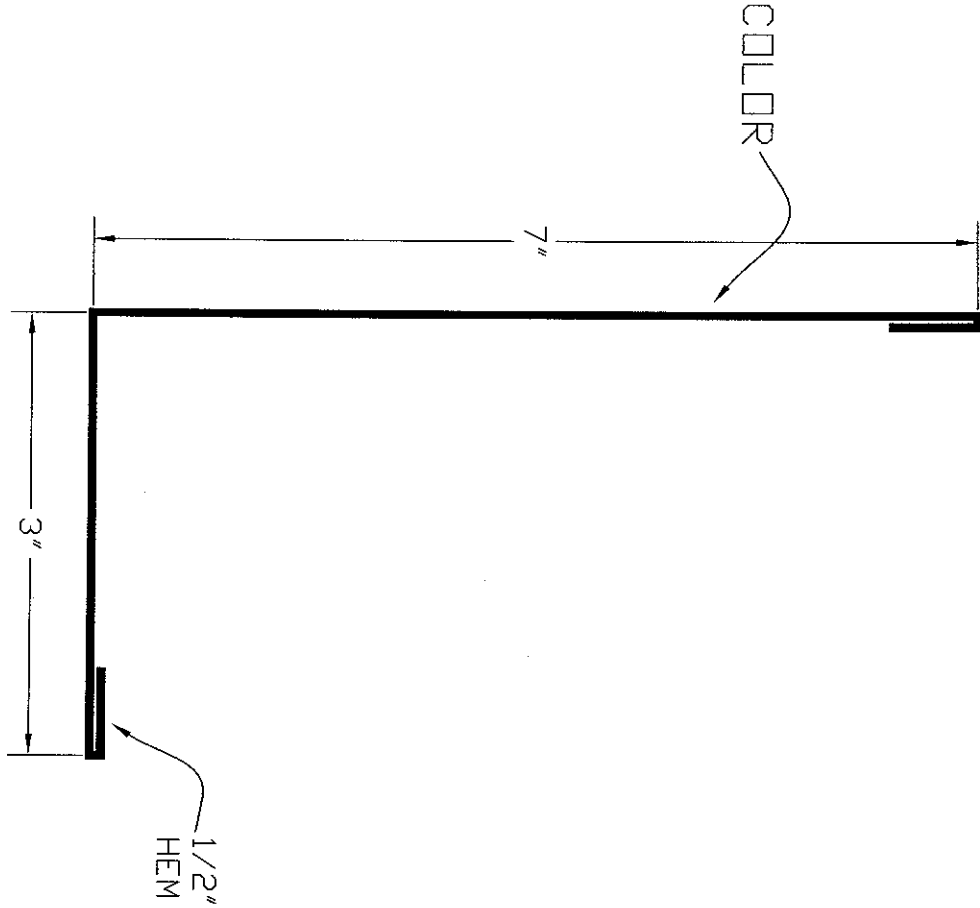

NOTES:

FL-2912S

7X3 OUTSIDE ANGLE SHEET BUMP

S.D.: 13 1/4"

pg. P17

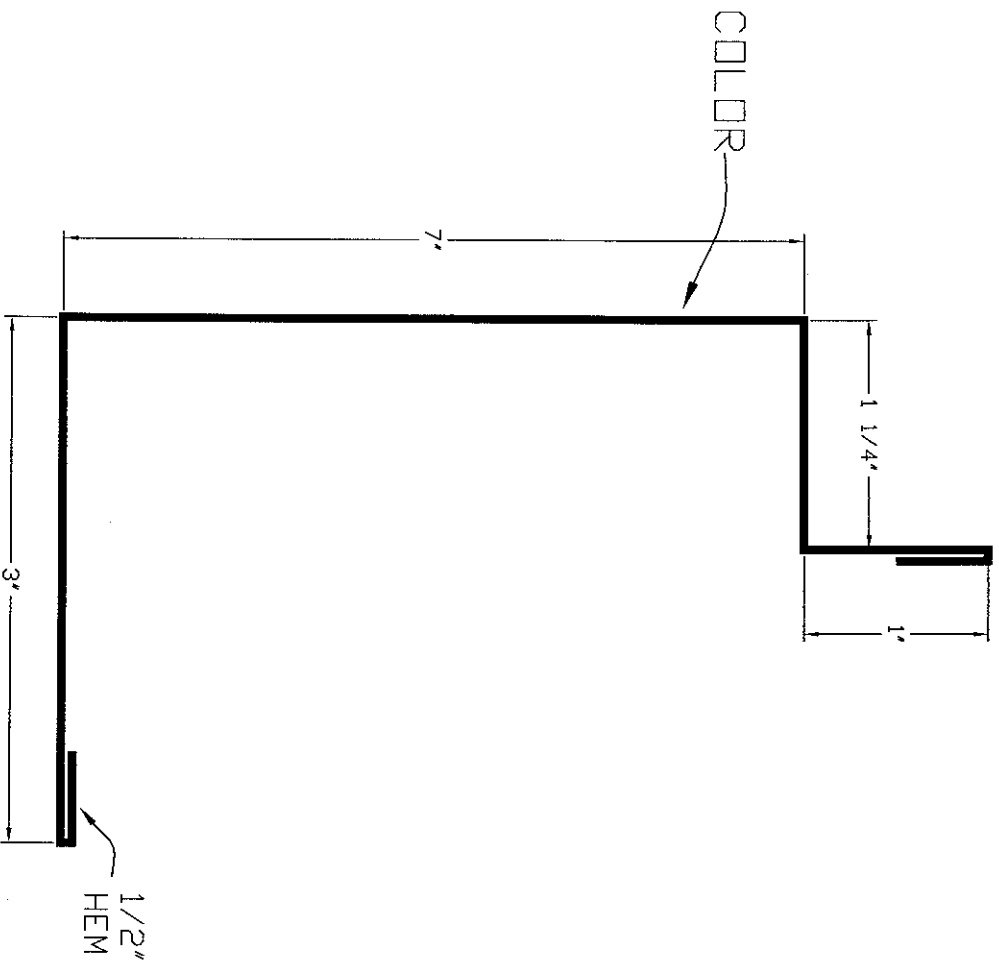

NOTES:

FL-30

3X3 INSIDE ANGLE

S.O.: 7"

pg. P18

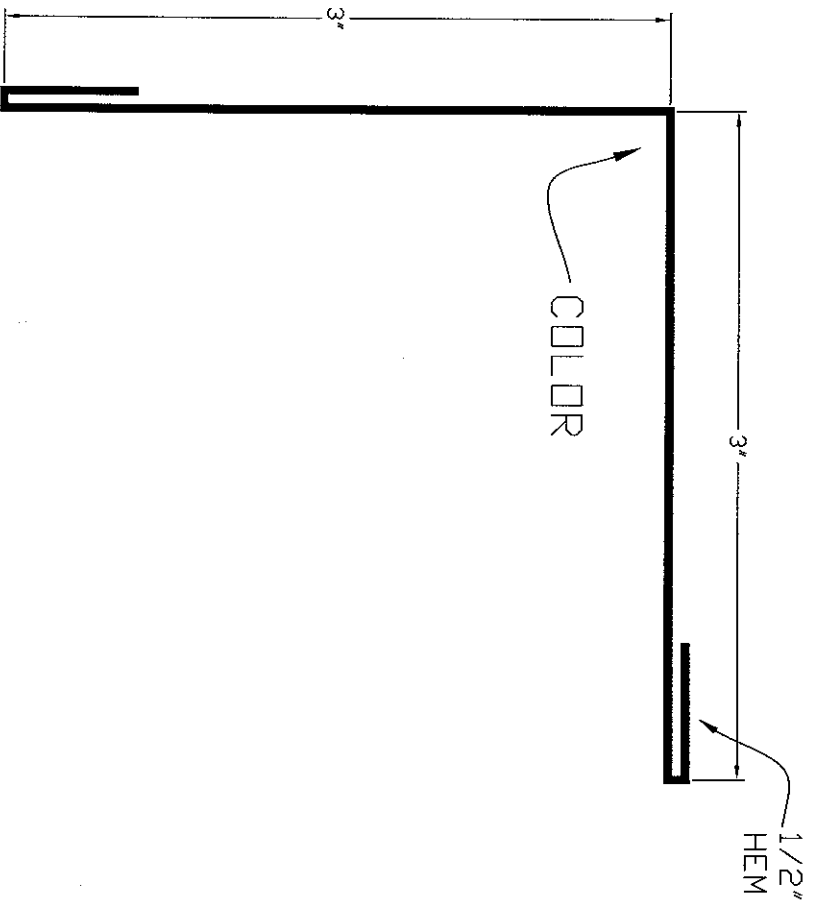

NOTES:

FL--31

DOWNSPOUT (STRAIGHT)

S.D.: 16"

pg. P19

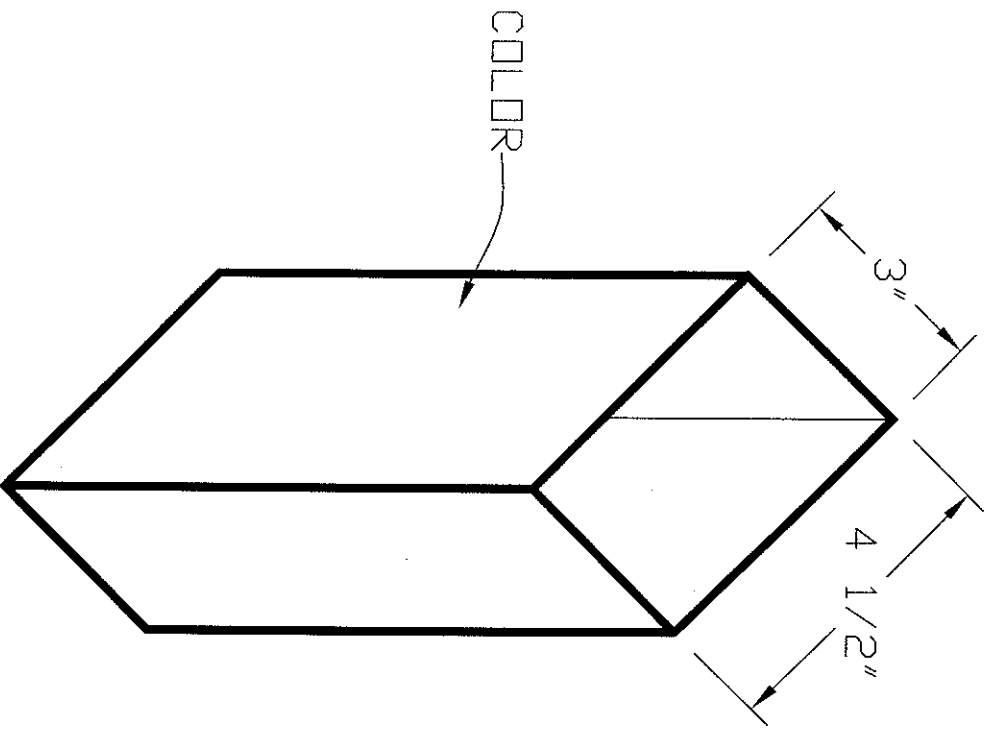

NOTES:

FL-31A

DOWNSPOUT (W/45° ELBOW)

S.D.: 16"

pg. P20

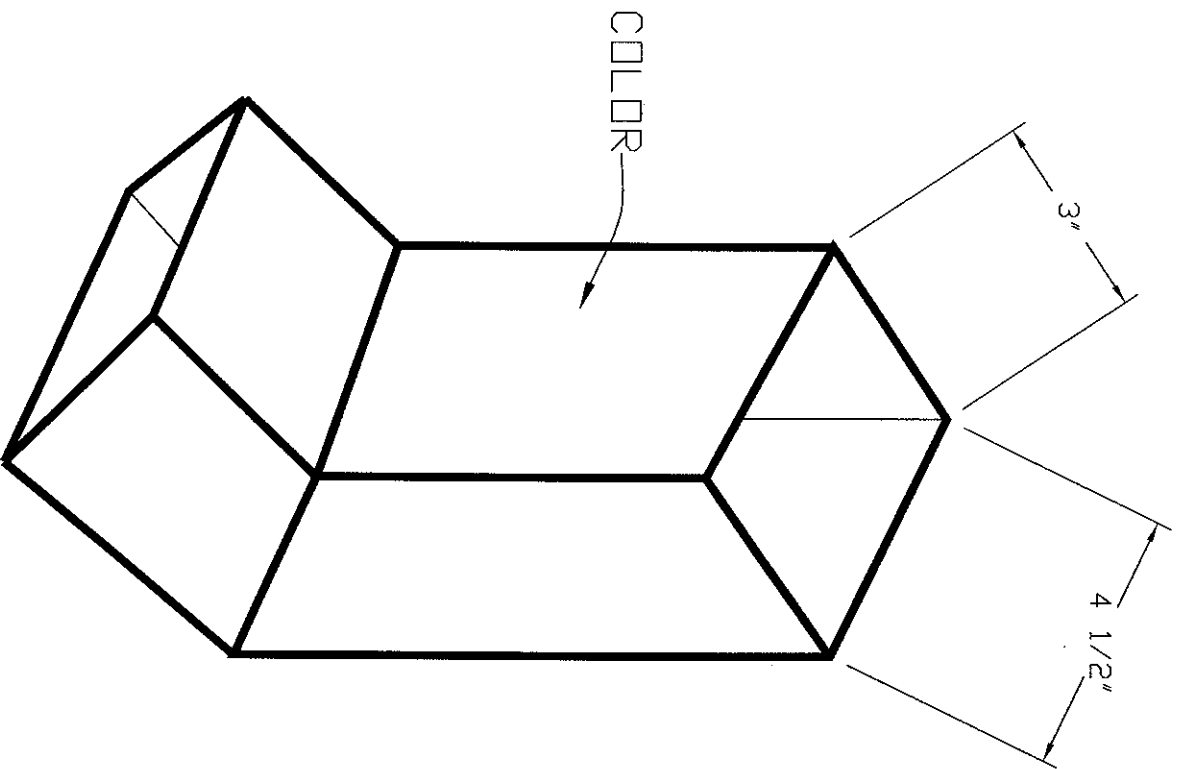

NOTES:

FL-788

2pc. DOWNSPOUT (W/45° ELBOW)

S.O.: 16"

pg. P21

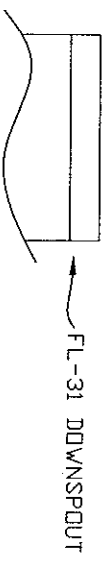
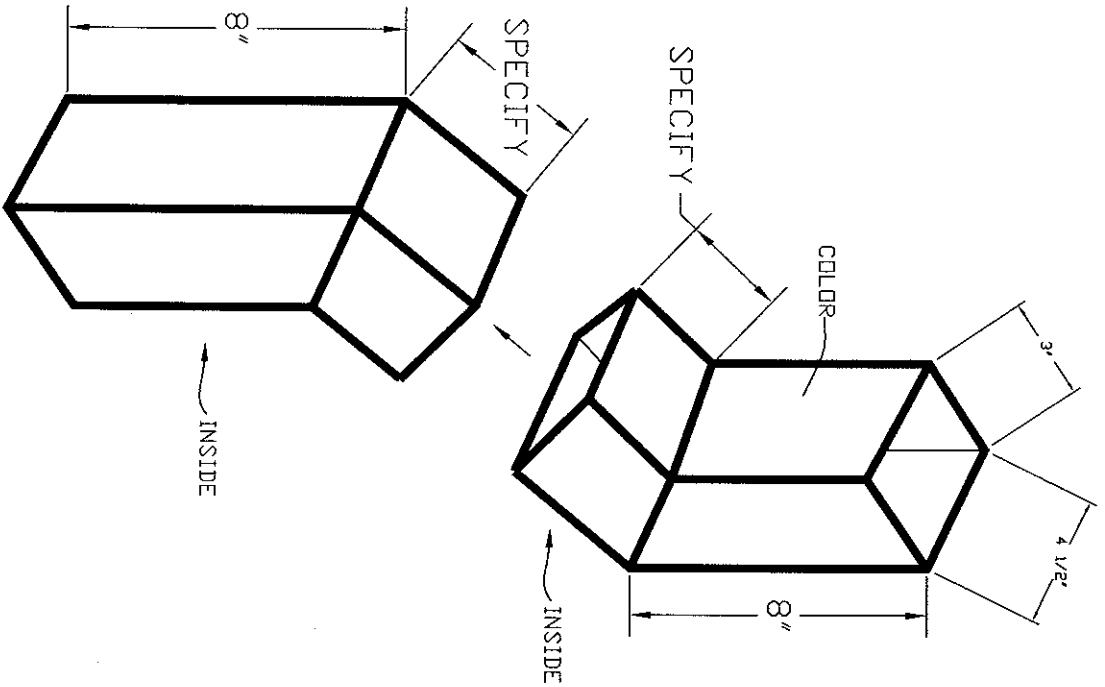

NOTES:

FL-37

JAMB OR HEAD COVER

S.D.: 14 1/8"

pg. P22

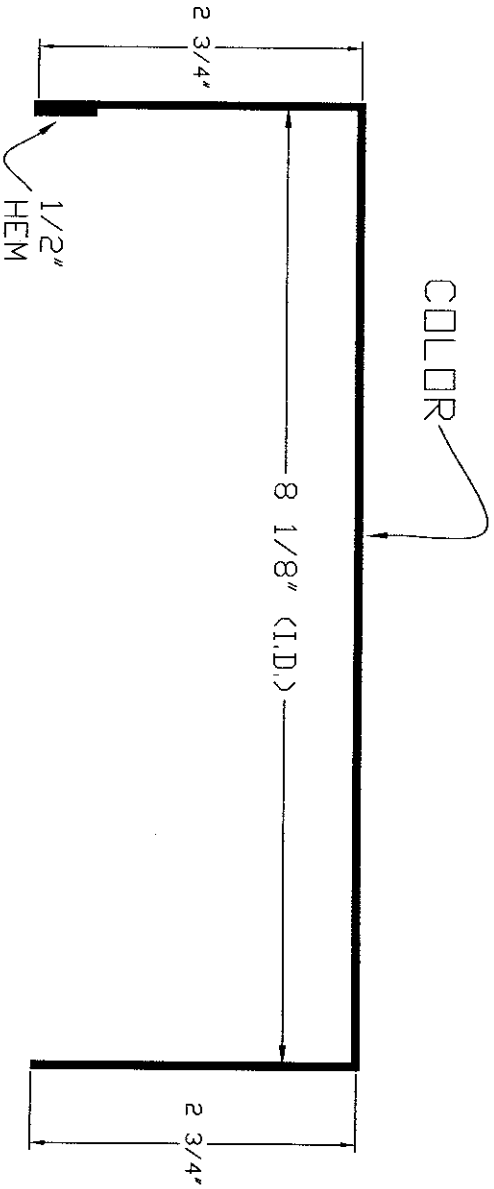

NOTES:

FL-3710

JAMB OR HEAD COVER

S.D.: 16 1/8"

pg. P23

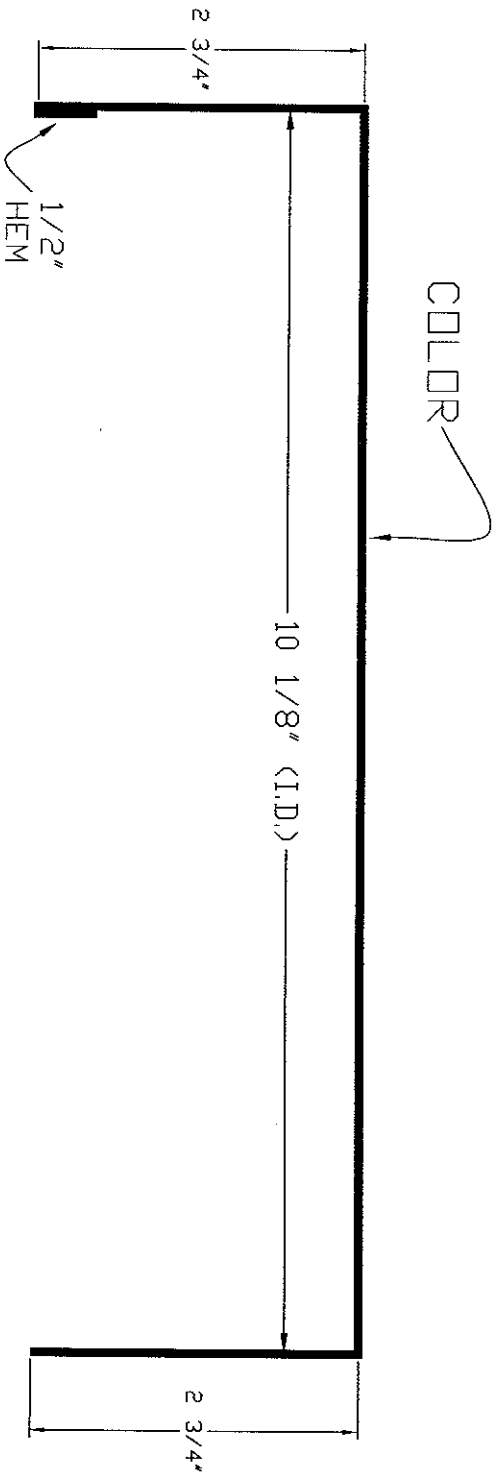

NOTES:

FL-3712

JAMB OR HEAD COVER

S.D.: 18 1/8"

pg. P24

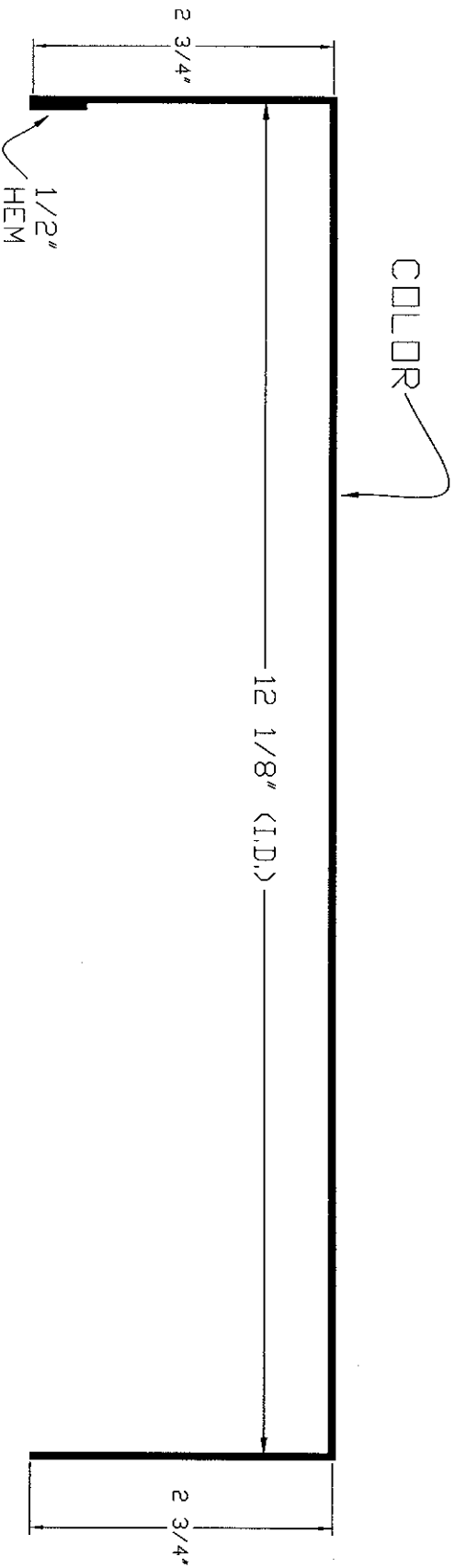

NOTES:

S.O.: 21 1/2"

pg. P25

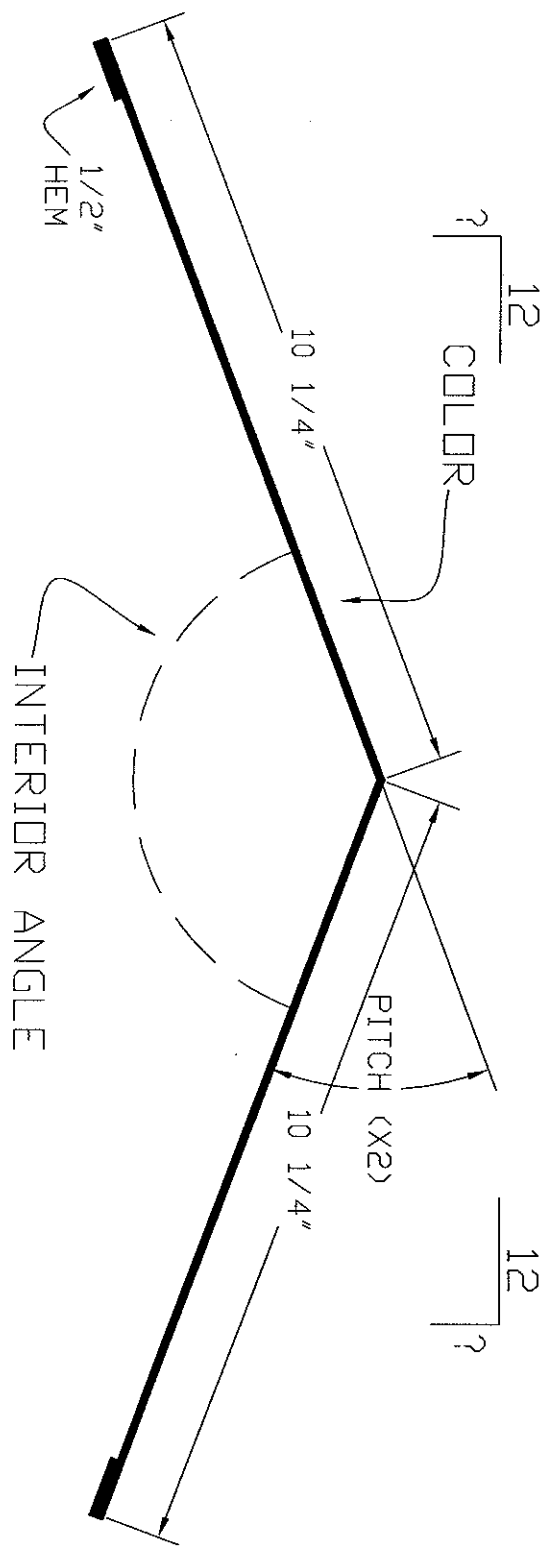

SPECIFY ROOF PITCH OR INTERIOR DEGREE

NOTES:

S.O.: 8"

pg. P26

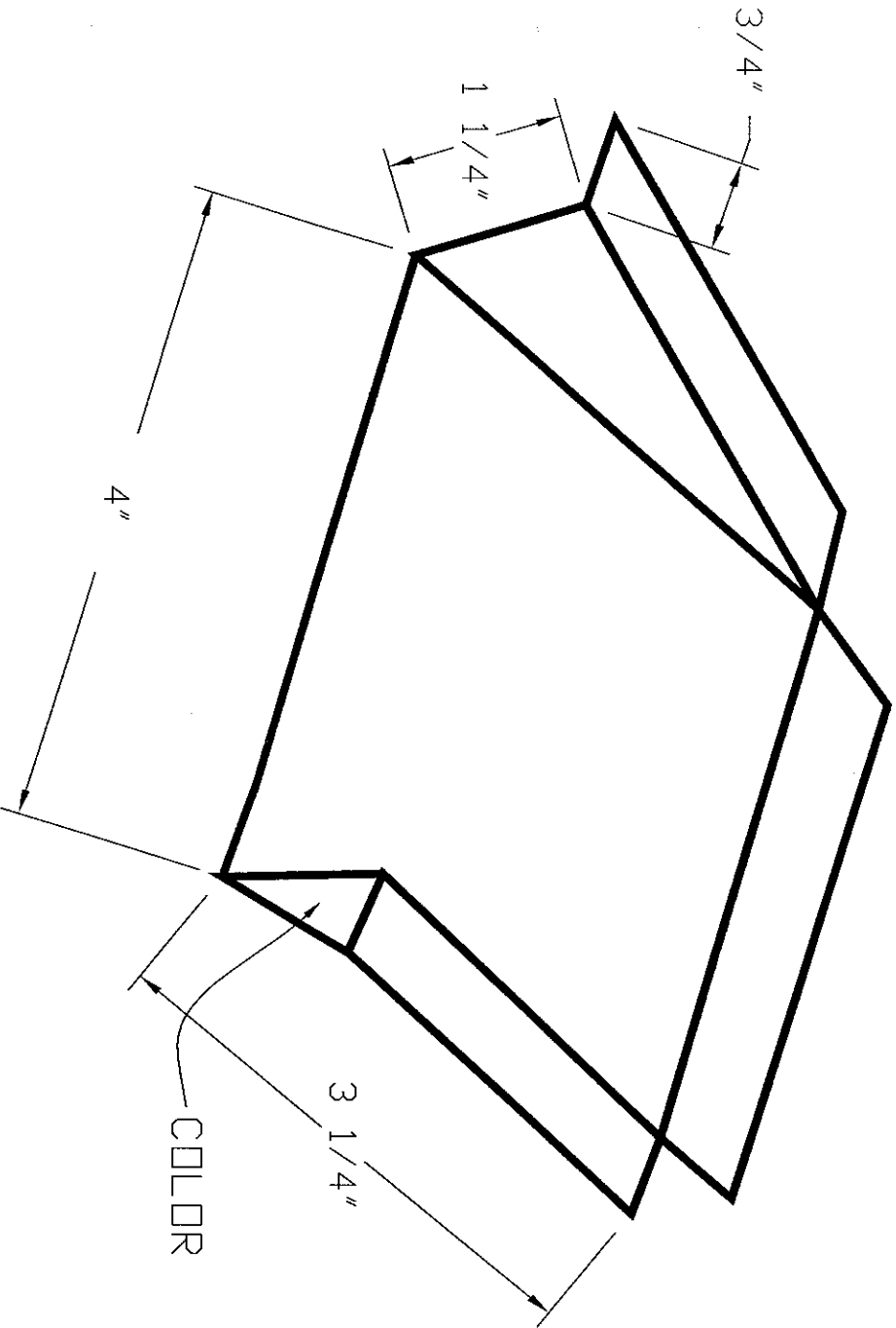

NOTES:

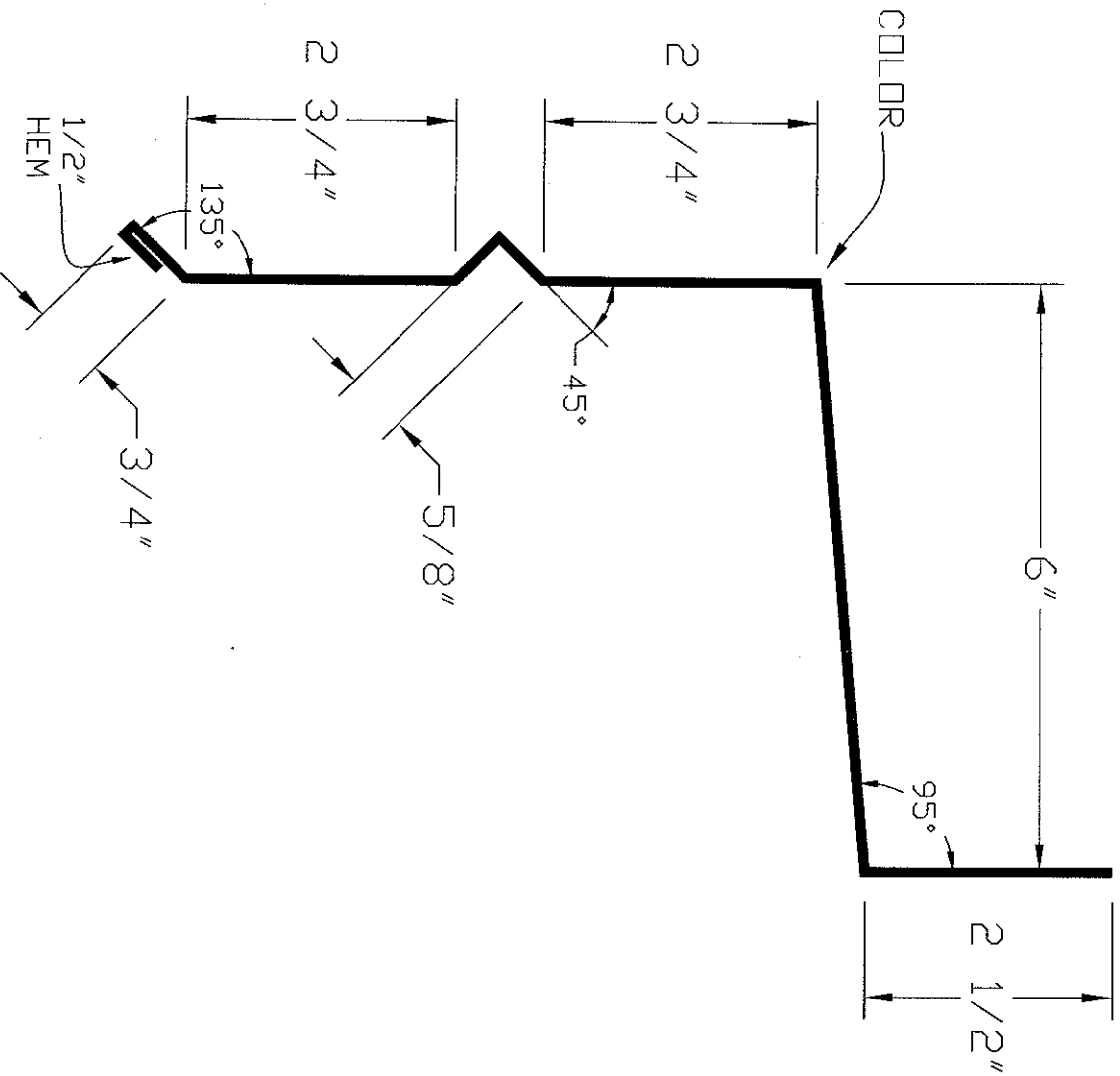

NOTES:

FL-46

"PBA" PANEL STARTER

S.D.: 8 3/8"

pg. P28

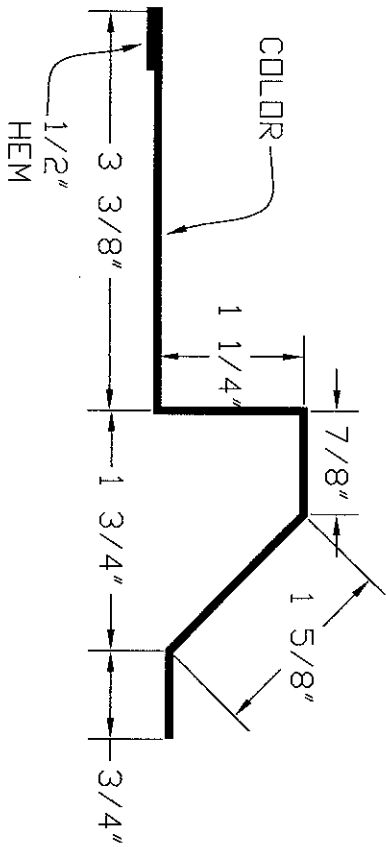

NOTES:

S.O.: 7"

pg. P29

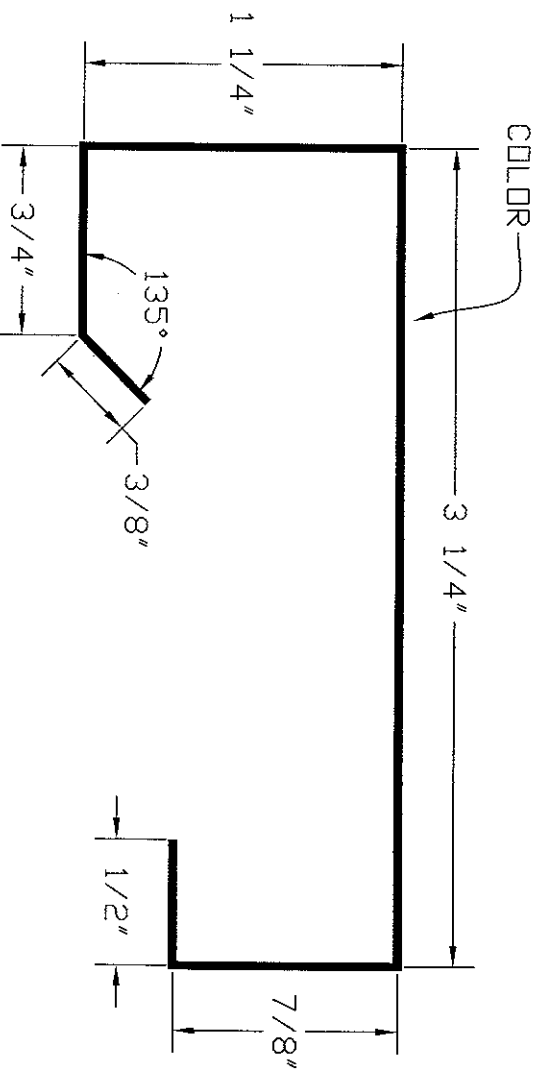

NOTES:

FL-65

U-FLASH LO EAVE

S.D.: 11 1/2"

pg. P30

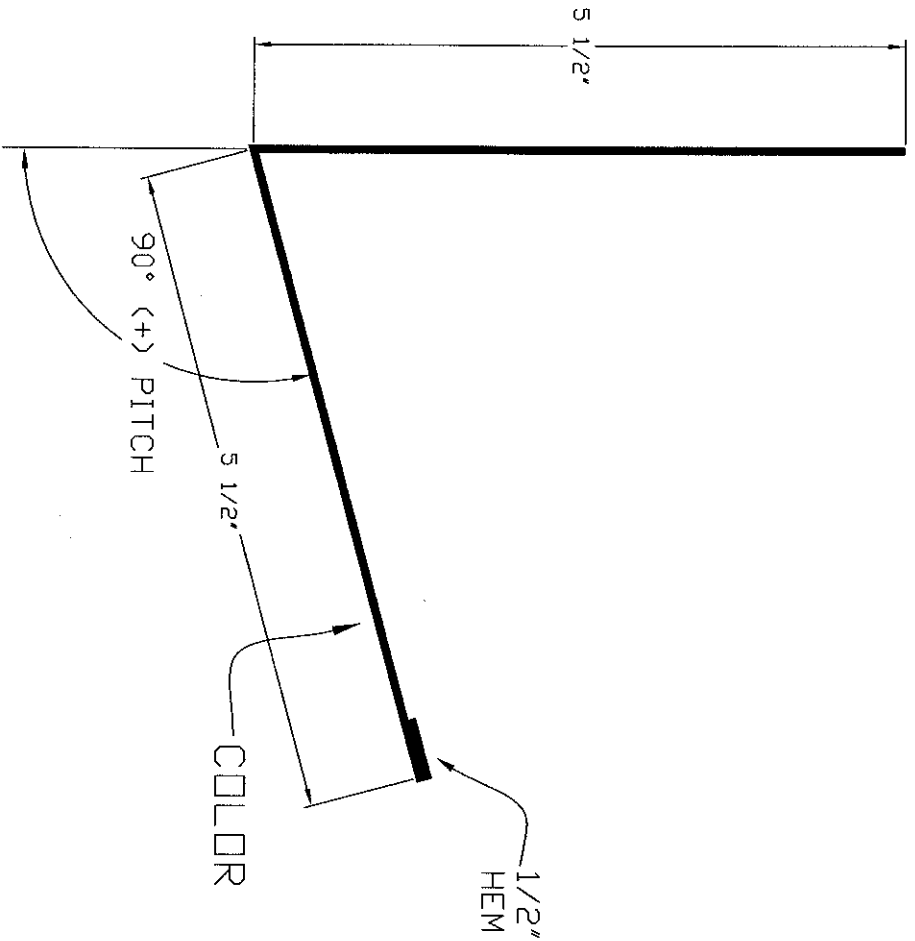

SPECIFY ROOF PITCH

NOTES:

FL-655

U-FLASH LO EAVE SHEET BUMP

S.D.: 13 3/4"

pg. P31

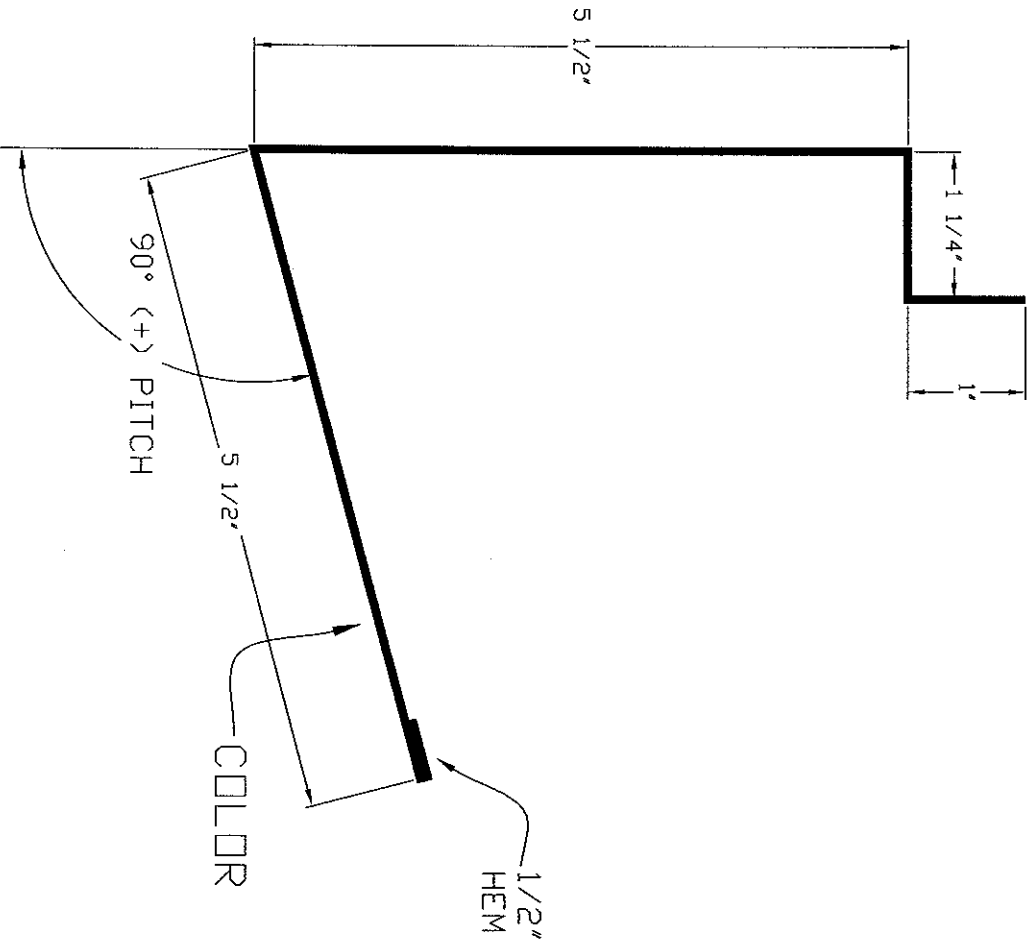

SPECIFY ROOF PITCH

NOTES:

FL-6510

U-FLASH LO EAVE

S.D.: 13 1/2"

pg. P32

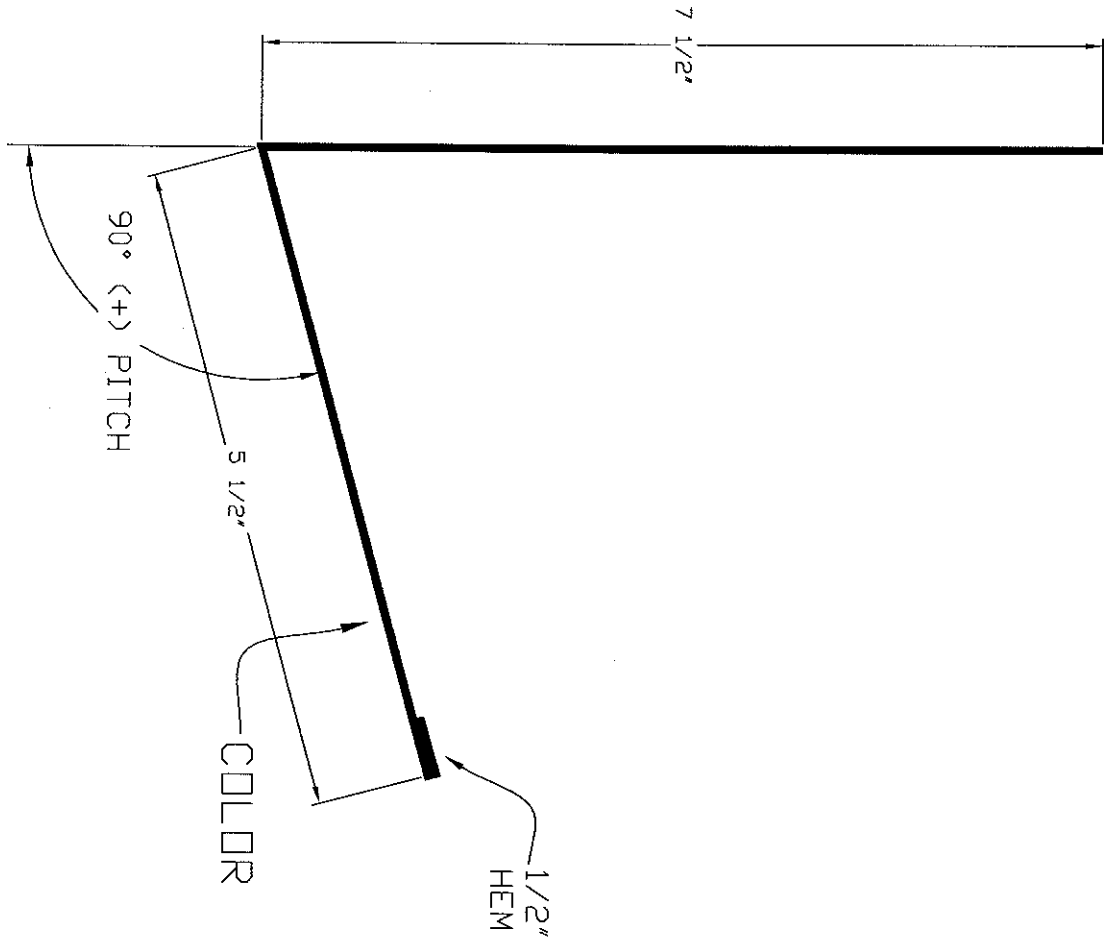

SPECIFY ROOF PITCH

NOTES:

FL-6510S

U-FLASH LO EAVE SHEET BUMP

S.D. 15 3/4"

pg. P33

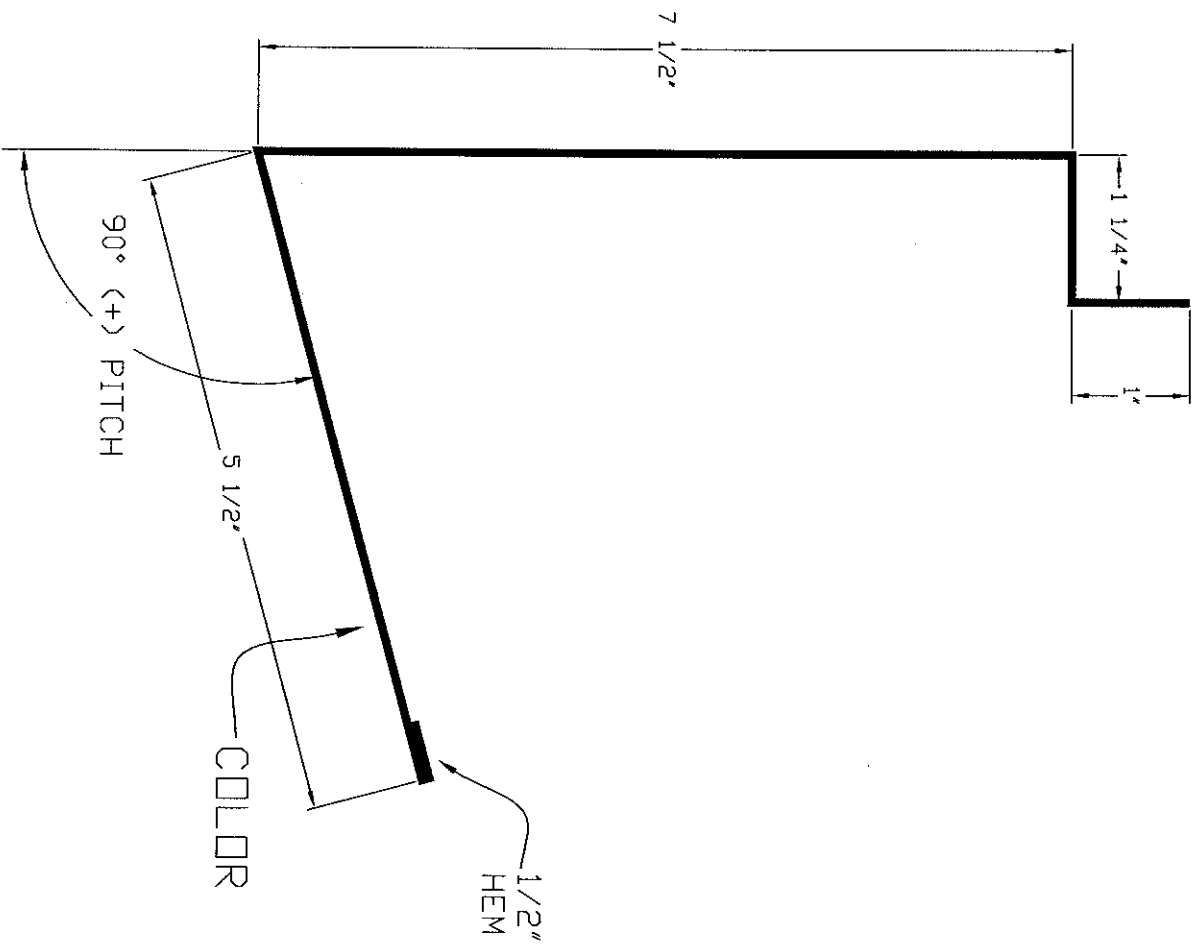

SPECIFY ROOF PITCH

NOTES:

FL-6512

U-FLASH LD EAVE

S.O.: 15 1/2"

pg. P34

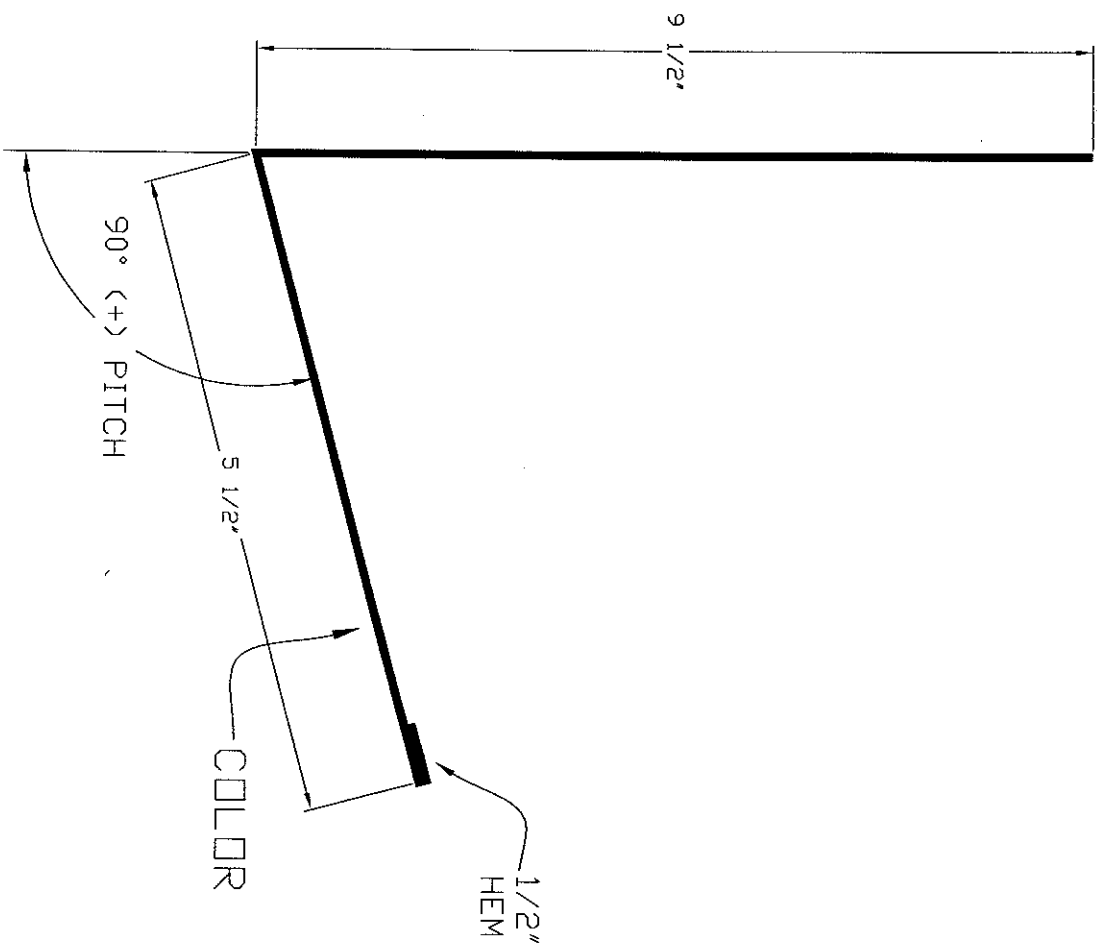

SPECIFY ROOF PITCH

NOTES:

FL-6512S

U-FLASH LO EAVE SHEET BUMP

S.O.: 17 3/4"

pg. P35

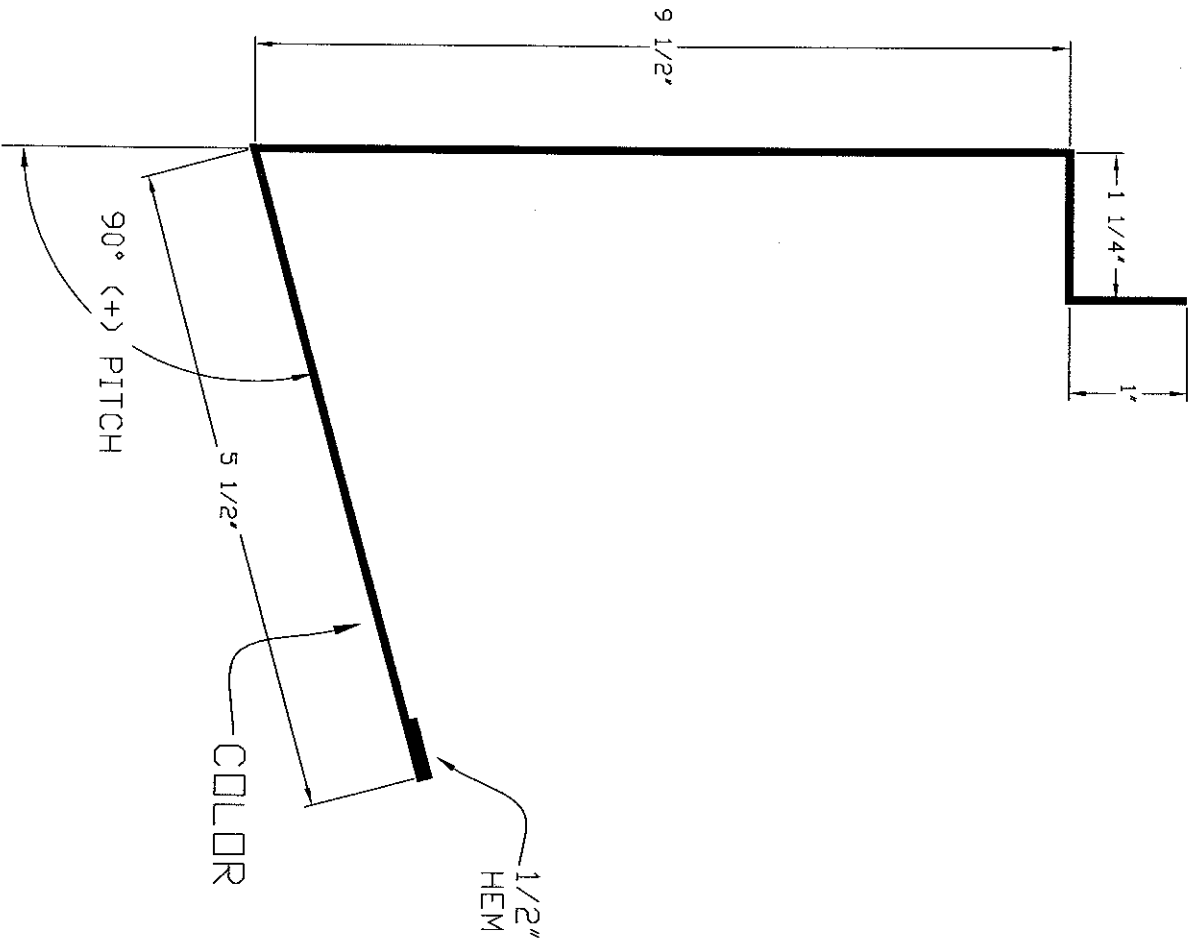

SPECIFY ROOF PITCH

NOTES:

FL-72

BASE TRIM - ALL PANELS

S.D. 6 1/8"

pg. P36

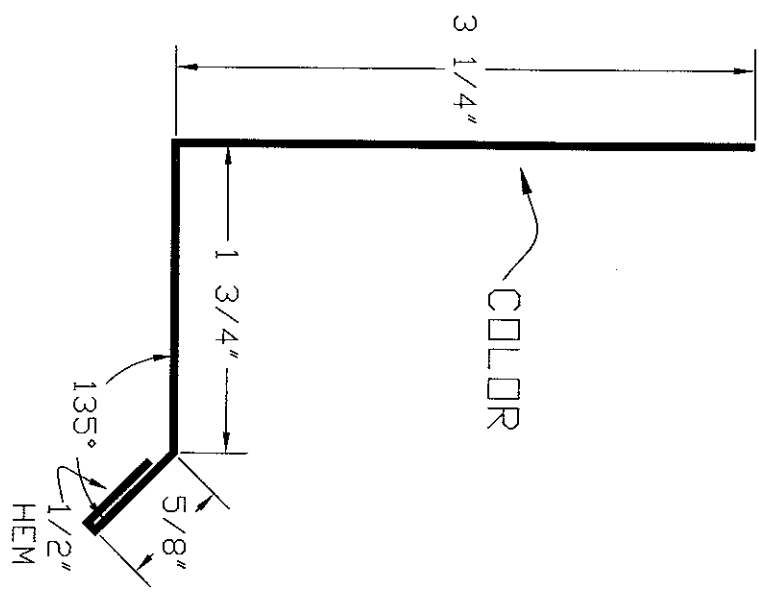

COLDR

NOTES:

FL-870

BASE FLASHING

SID: 9"

pg. P37

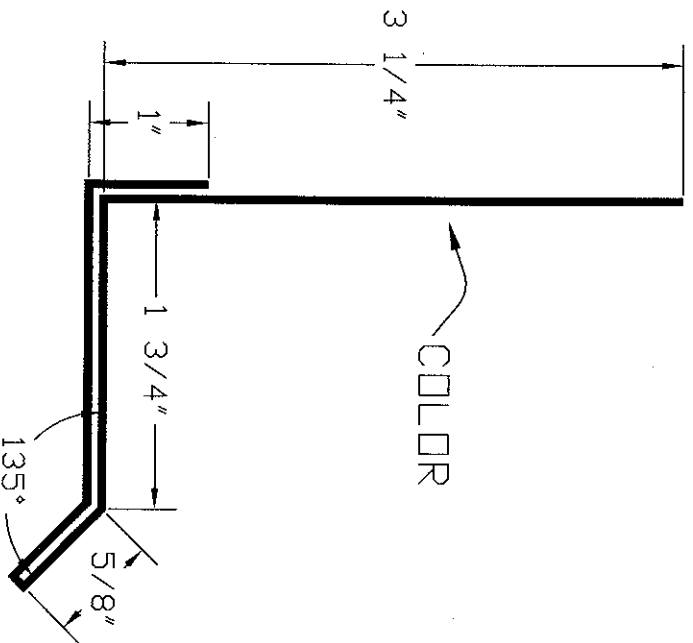

NOTES:

FL-74

BOX HANG-ON GUTTER

S.D.: 17 1/2"

pg. P38

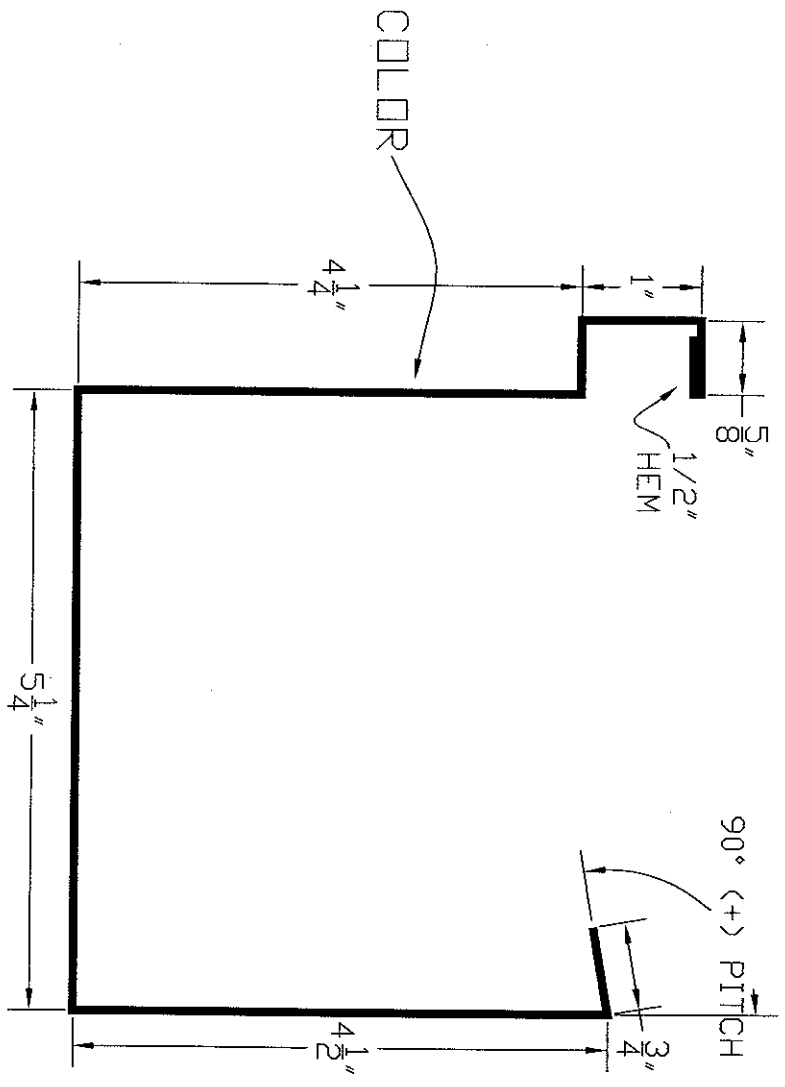

SPECIFY ROOF PITCH

NOTES:

FL-75

LIGHT TRANSMITTING PANEL CAP ("R" PANEL)

S.O.: 6 1/4"

pg. P39

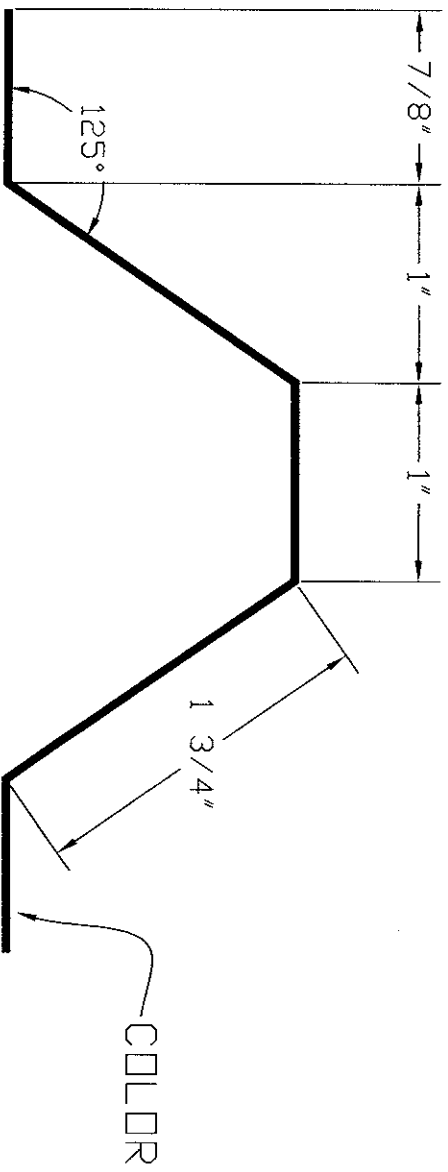

NOTES:

FL-195

PARAPET HIGH EAVE TRIM

S.O.: 13 3/4"

Pg. P40

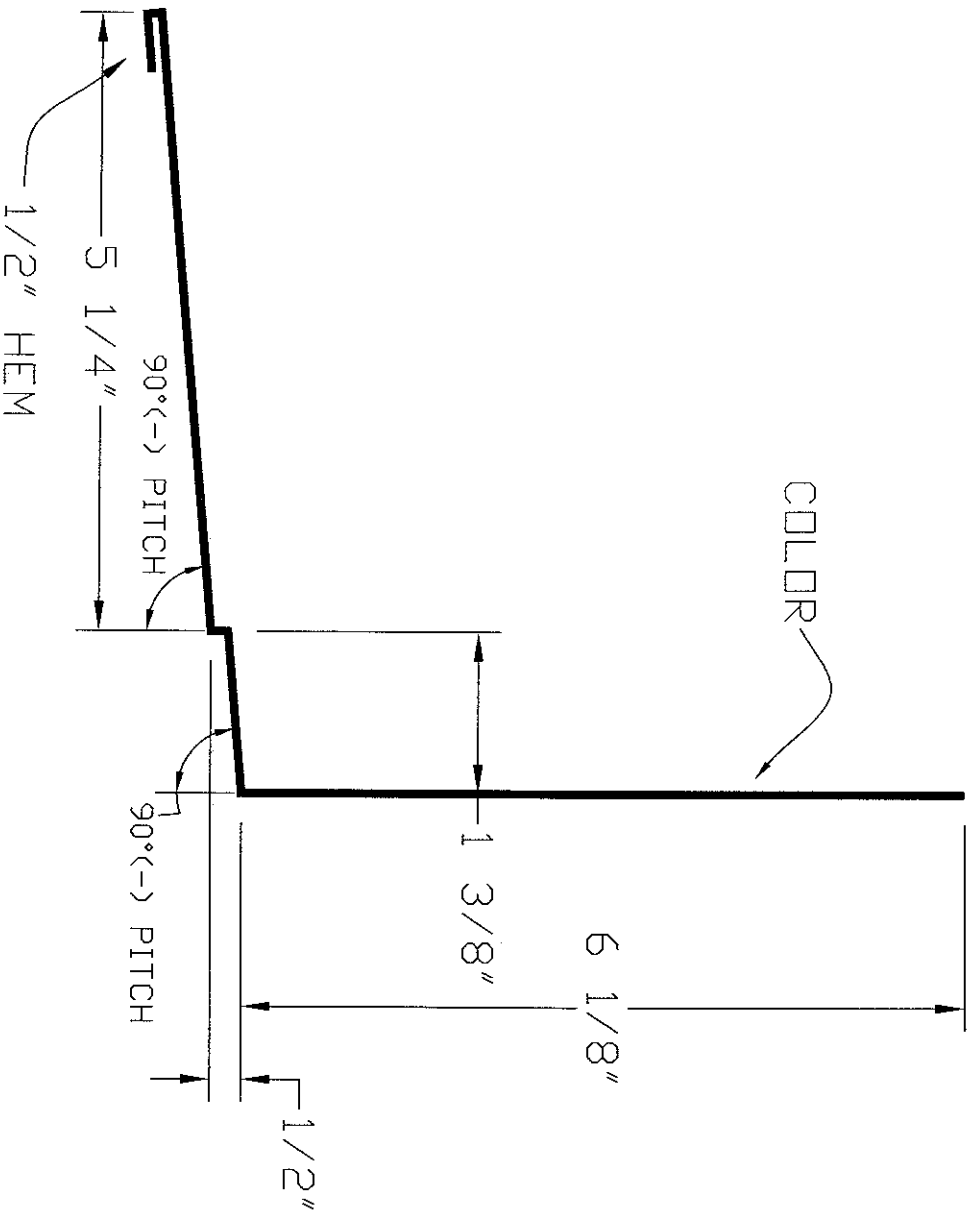

SPECIFY ROOF PITCH

NOTES:

FL-272

COUNTER FLASHING (USED W/ FL-18C)

S.O.: 8"

Pg. P41

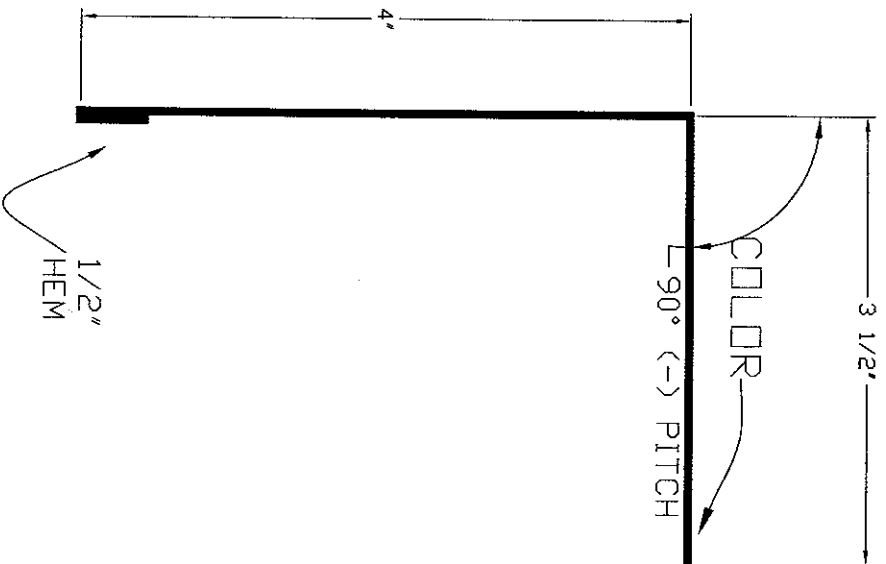

SPECIFY ROOF PITCH

NOTES:

FL-451

SLIDING DOOR HOOD

S.D.: 19 1/4"

pg. P42

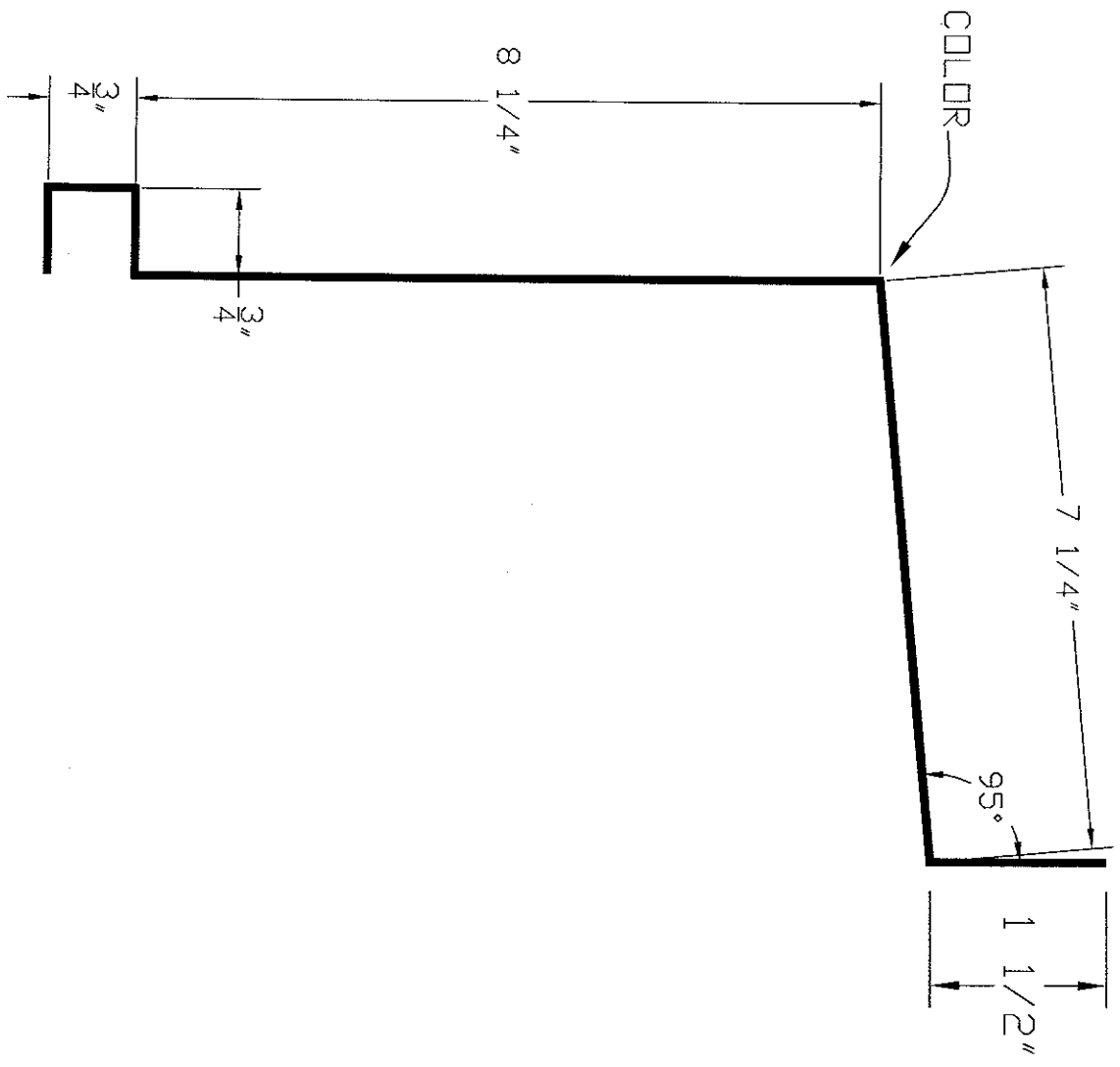

NOTES:

S.O.: 21 1/2"

pg. P43

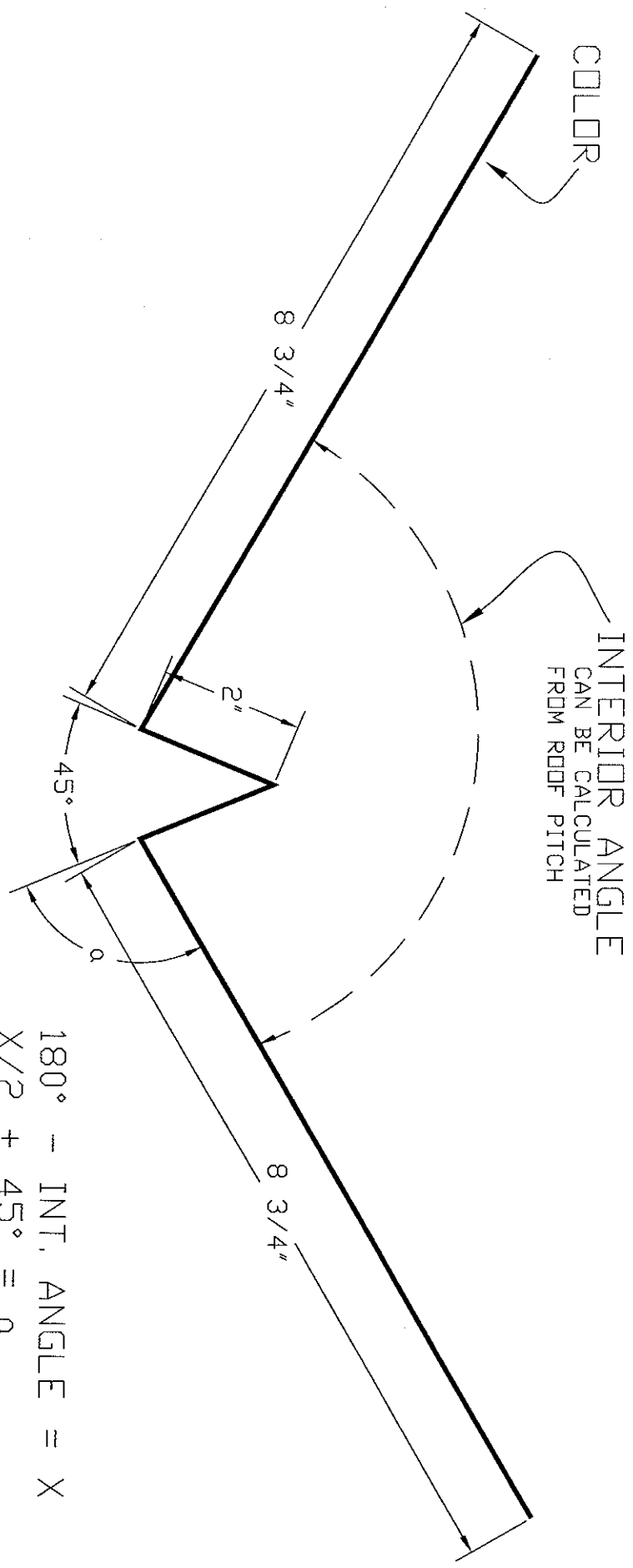

$$180^\circ - \text{INT. ANGLE} = X$$

$$X/2 + 45^\circ = \alpha$$

SPECIFY ROOF PITCH OR INTERIOR DEGREE

NOTES:

FL-797

DOWNSPOUT STRAP

S.D.: 9 3/4"

pg. P44

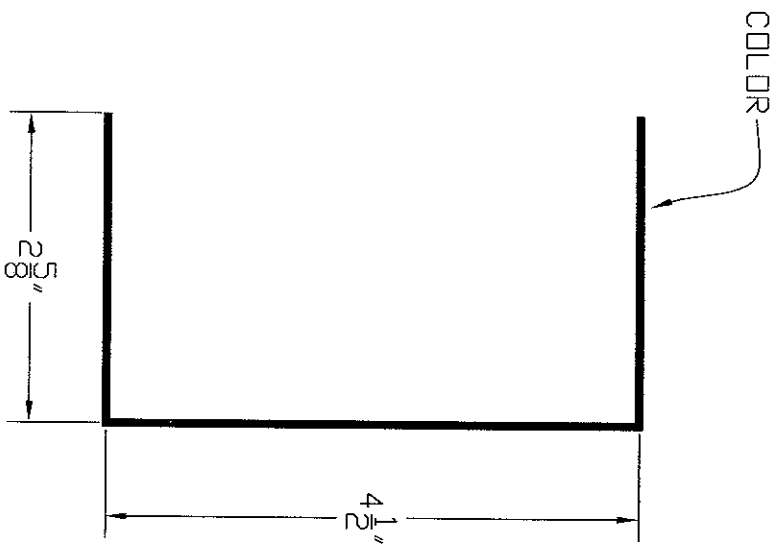

NOTES: